

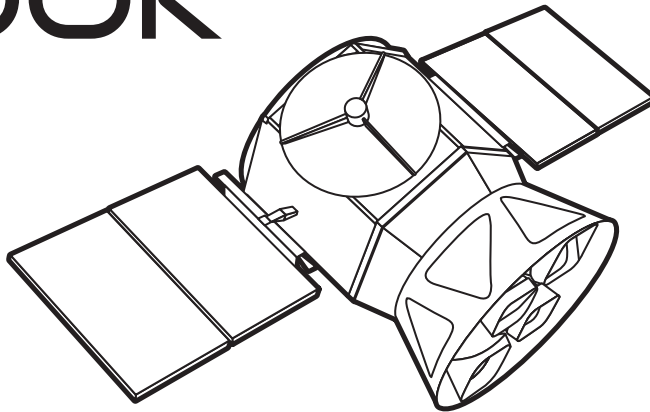

# EXOPLANET COLORING BOOK

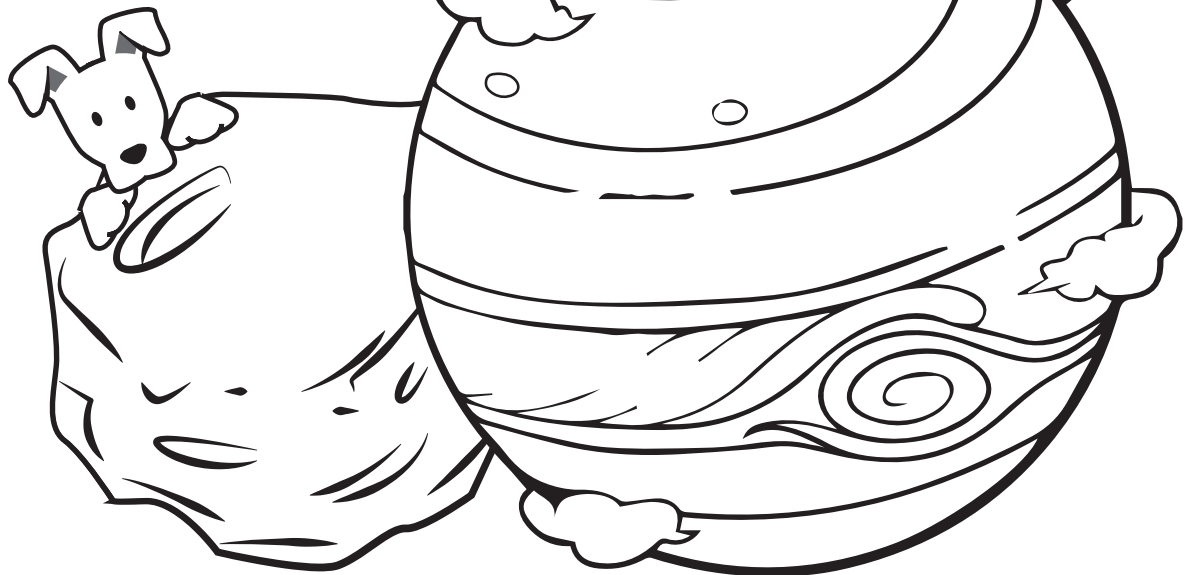

Have fun while learning  
about Exoplanets,  
Transit Science, and  
the Transiting Exoplanet  
Survey Satellite (TESS)



---

Name

---

School

---

Grade

*Note to Parents and Educators:*

This Coloring Book is designed for ages 5 through 10.

It contains general information about NASA and TESS.

**EXPLORE  
MORE**

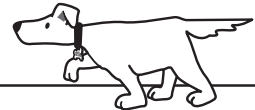

For more information on  
NASA and the TESS mission,  
visit these web sites:

<http://education.nasa.gov>

<http://nasascience.nasa.gov/>

<http://tess.gsfc.nasa.gov/>

<http://www.nasa.gov>

# ***INTRODUCING TESSie***

*Welcome to TESSie's Universe!*



TESSie is our very own planet finder! She will sniff around and point out exciting facts about exoplanets and NASA's TESS Satellite.

Look for TESSie throughout this activity book!

# WHAT IS AN EXOPLANET?

*New Worlds Outside of Our Solar System!*

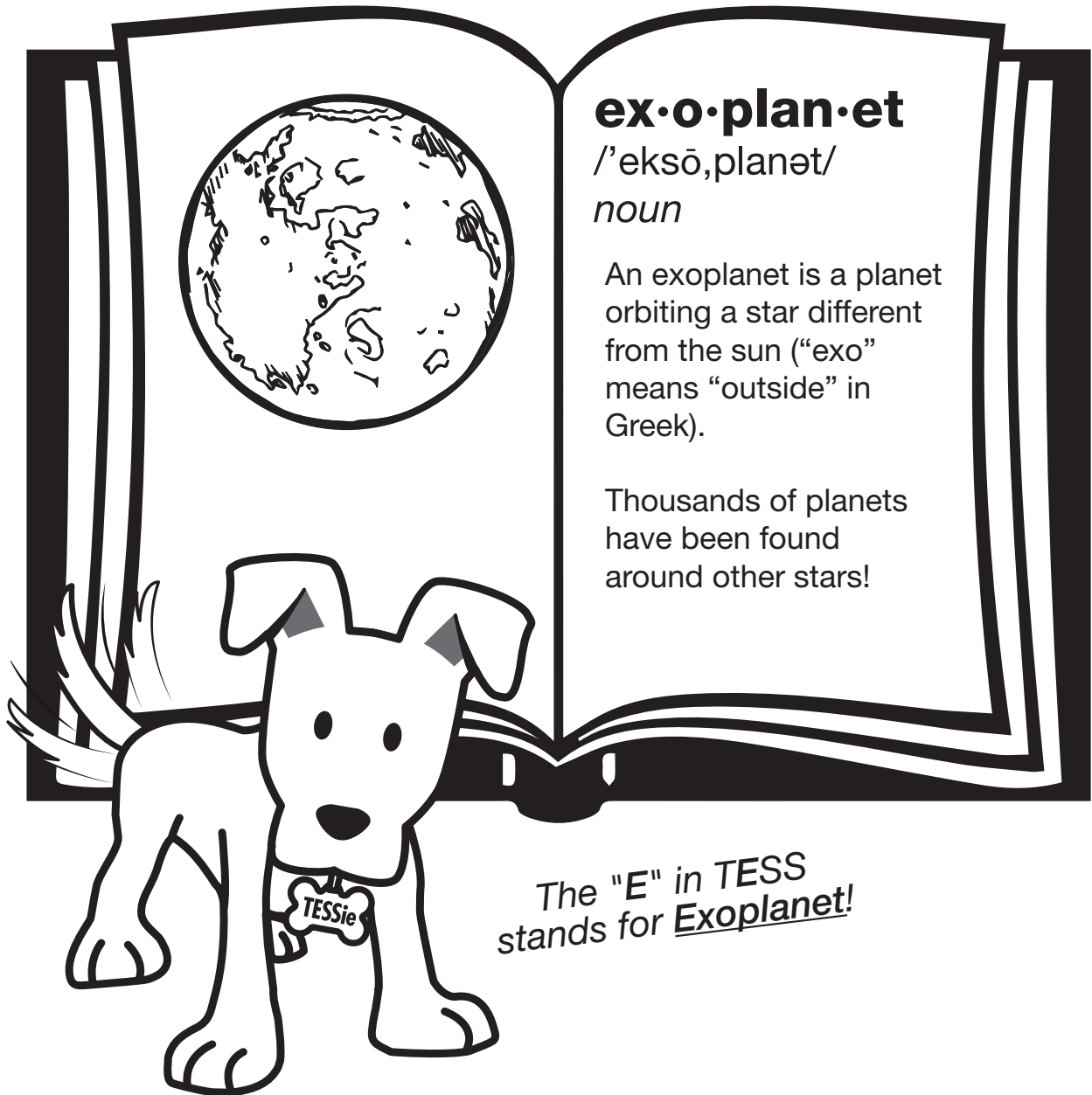

## **ex·o·plan·et**

*/'eksō,planət/*

*noun*

An exoplanet is a planet orbiting a star different from the sun (“exo” means “outside” in Greek).

Thousands of planets have been found around other stars!

The “E” in TESS stands for Exoplanet!

Planets may be different from Earth. What kind of planets do you think are out there?

# TOUR GUIDE TESSie

Let's Look at What TESS Will Find

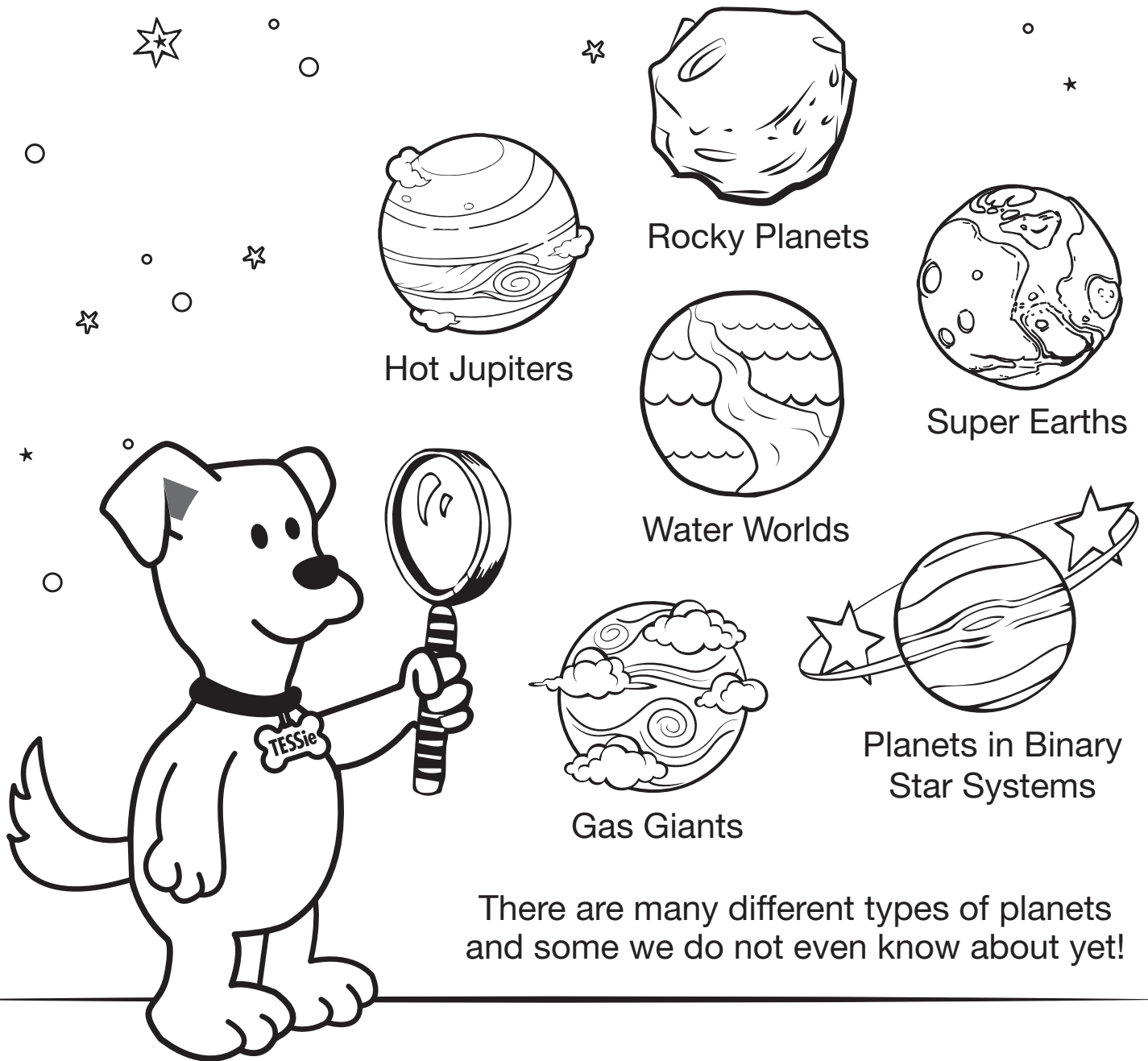

There are many different types of planets and some we do not even know about yet!

Exoplanets are also in different orbits around their stars. If an orbit is too close, the exoplanet will be very hot. If it has an orbit that is too far away from its star, the exoplanet will be very cold. When an exoplanet's orbit is not too close or too far away from its star, the temperature may be just right to have water and maybe life (like Earth).

We call this the *habitable zone*.

# **HOT JUPITERS**

*Color It Red Hot*

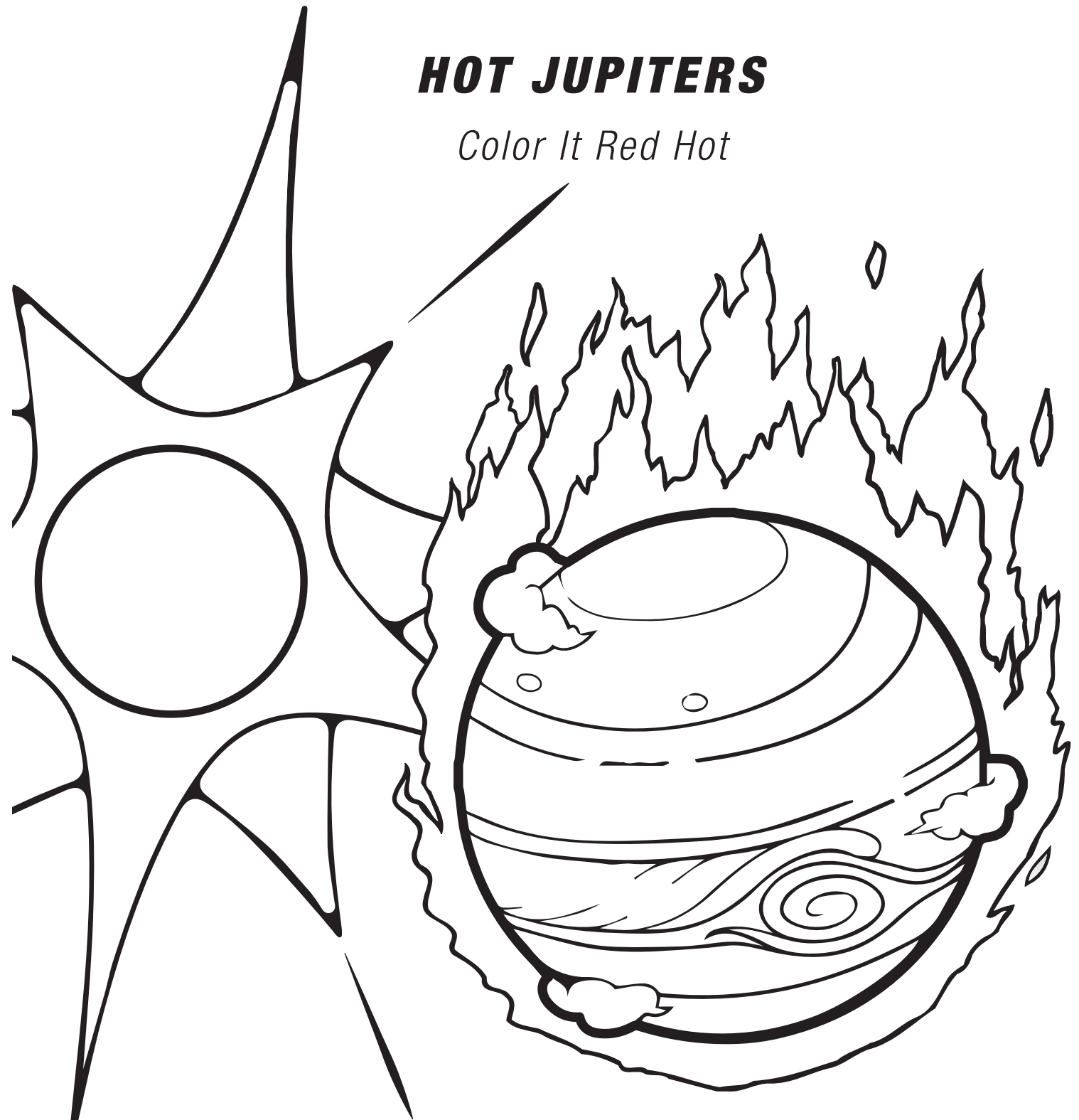

Hot Jupiters are very large gas planets that are close to their star. Some are so hot that their atmospheres are boiling away into space. A year is when the planet revolves around its sun one time. Hot Jupiters may complete one revolution in just a few hours—this makes their year very short.

# ***WATER WORLDS***

*Water, Water Everywhere*



Some exoplanets may be made of mostly water,  
with large oceans covering them.

# ***ROCKY PLANETS***

*Rock Around the Galaxy*



Some exoplanets are made mostly of rocks and metals. They are smaller than the large gas planets. Mars, Earth, Venus, and Mercury are Rocky Planets in our solar system.



# **EXOPLANETS IN BINARY STAR SYSTEMS**

*Are You Seeing Double?*

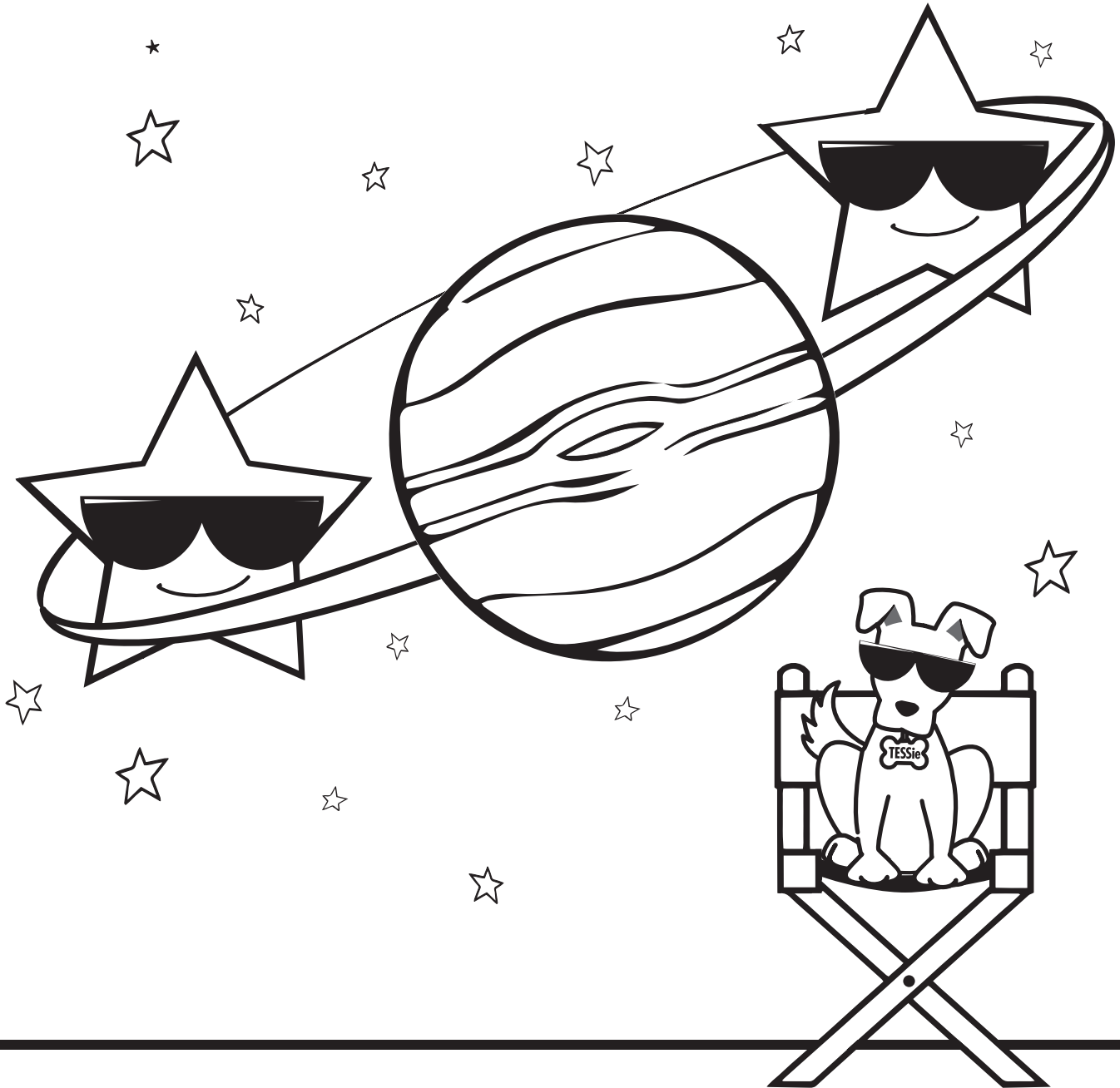

This exoplanet orbits two stars (called binary) in the same system. Think about what it would be like seeing two sunrises and sunsets!

# ***SUPER EARTHS***

*Super Duper*

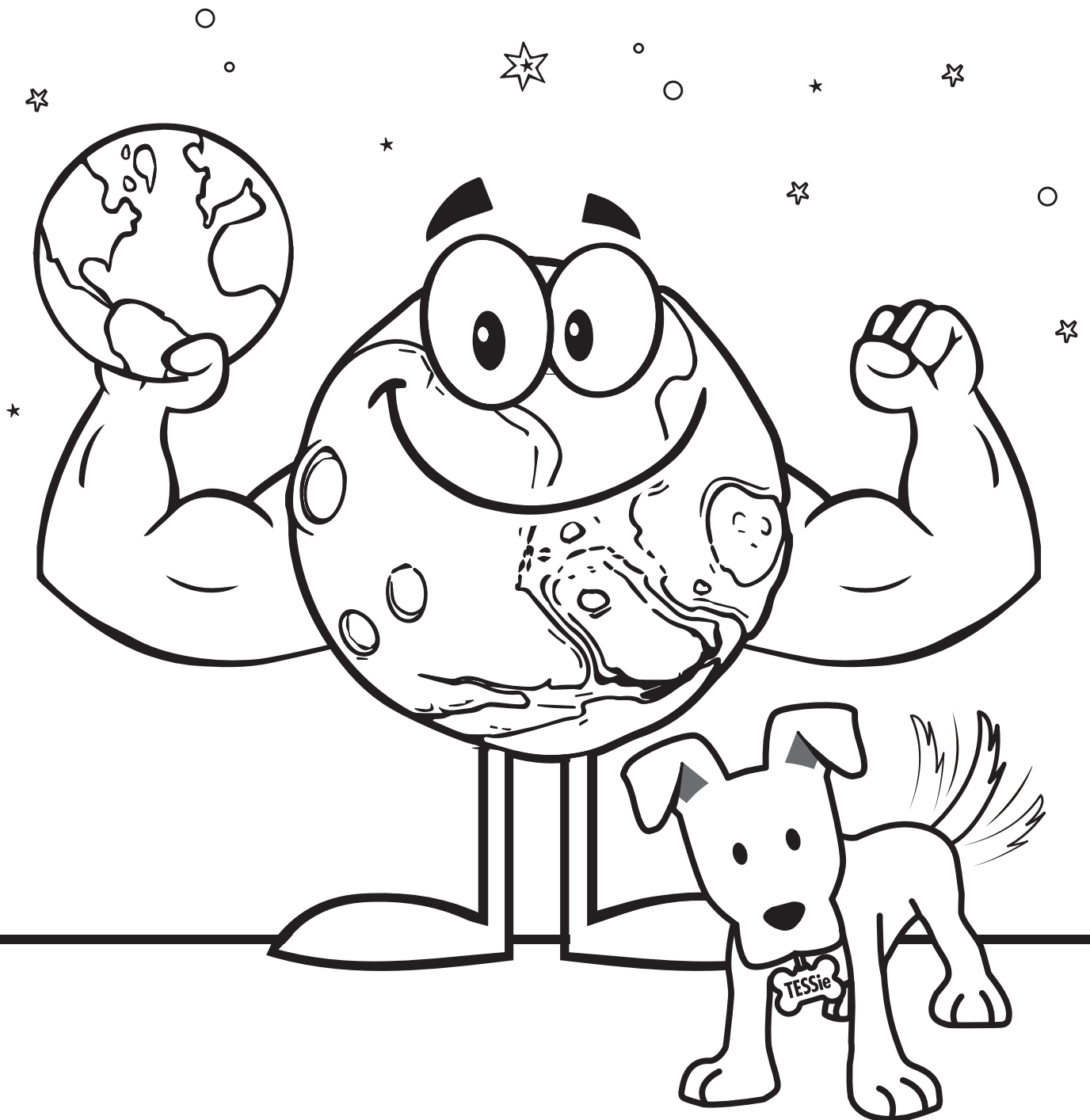

Wow, TESSie found a planet that is rocky like Earth, but much bigger. This planet is called a Super Earth and it can be twice the size of Earth, but it is smaller than gas exoplanets.

# ***GAS GIANTS***

*Huge Fuming Planets*



Gas giants have many layers of a very cloudy atmosphere. These exoplanets are much larger than the rocky worlds; when the size of a planet core becomes so large, it is able to capture all kinds of gases to form a thick atmosphere.

# **ICY COLD**

*Chilly Dog*



This exoplanet is too far away from its star and is freezing cold. TESSie can't live here.

**UNINHABITABLE!**

# **FLAMING HOT**

*Hot Dog!*

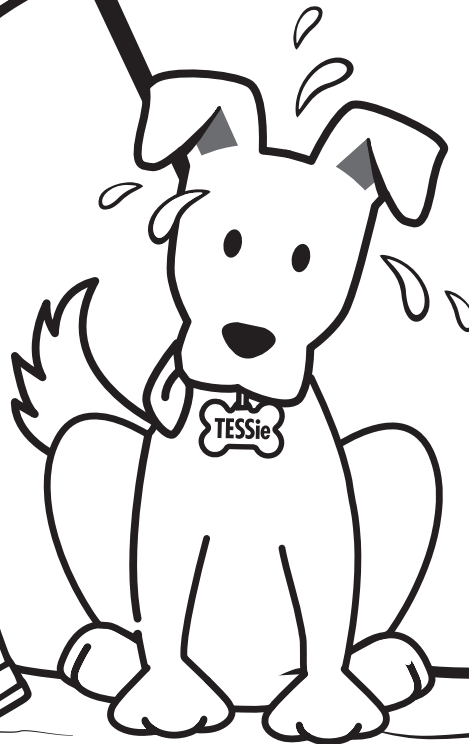
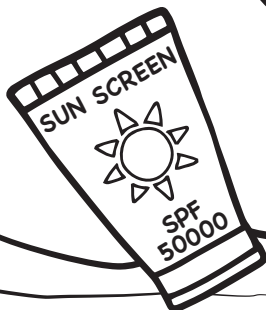
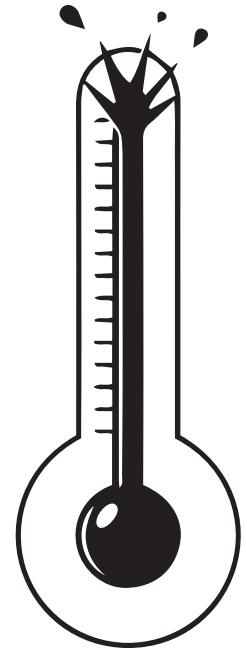

This exoplanet is too close to its star. TESSie can't live here.  
**UNINHABITABLE!**

# ***THIS ONE IS JUST RIGHT***

*Comfy and Cozy*



This exoplanet is just right. Not too cold that water may be frozen and not too hot that it boils away. TESSie would love this planet.

**THIS IS IN THE HABITABLE ZONE!**

# **IMAGINE YOUR OWN PLANET**

*What Would It Be Like on This Exoplanet?*

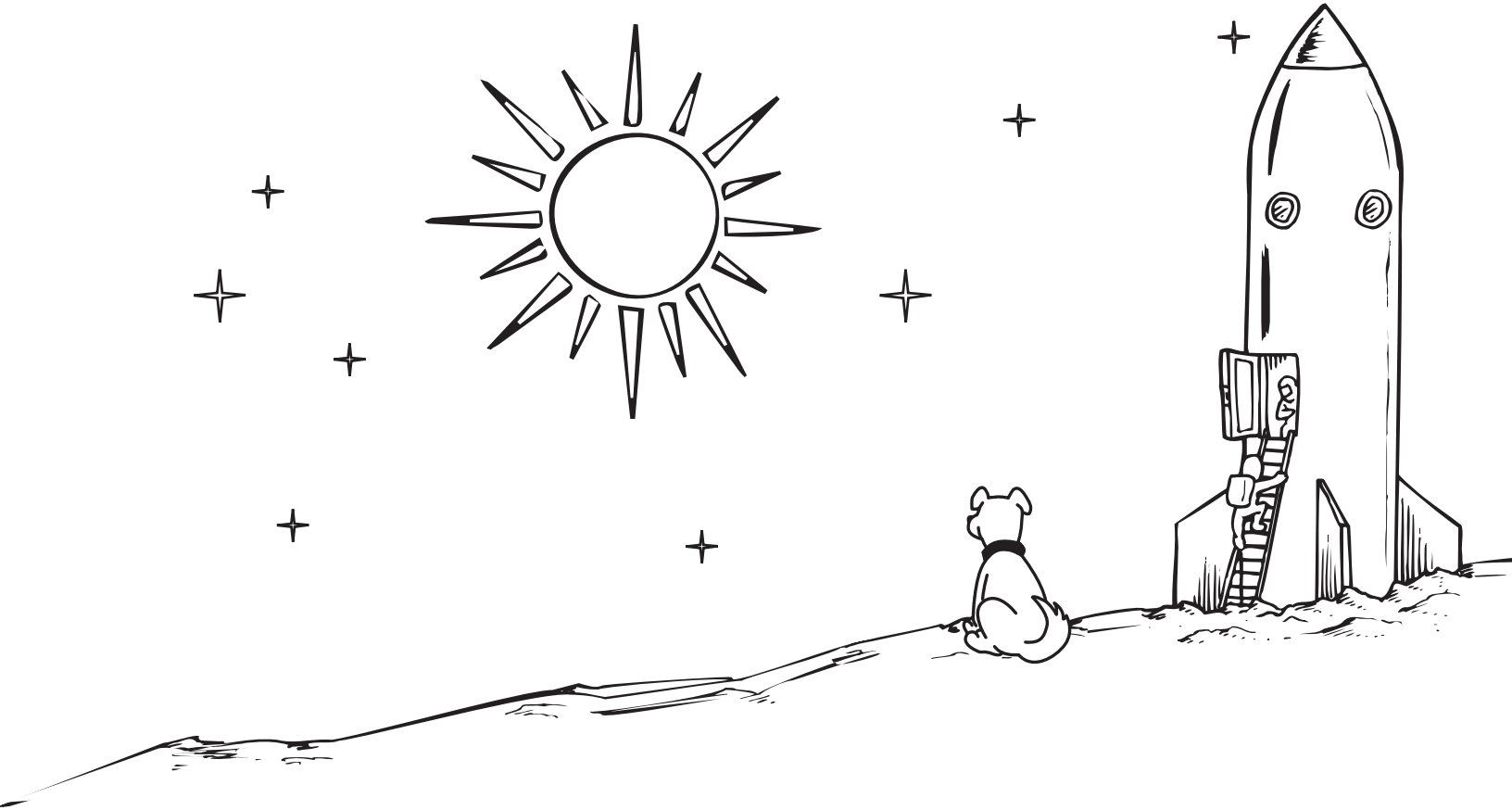

This exoplanet is named \_\_\_\_\_.

Draw the things that TESSie and the astronauts will find on this exoplanet.

# **TRANSIT - WHAT DOES IT MEAN?**

*Let's Watch a Transit Together*

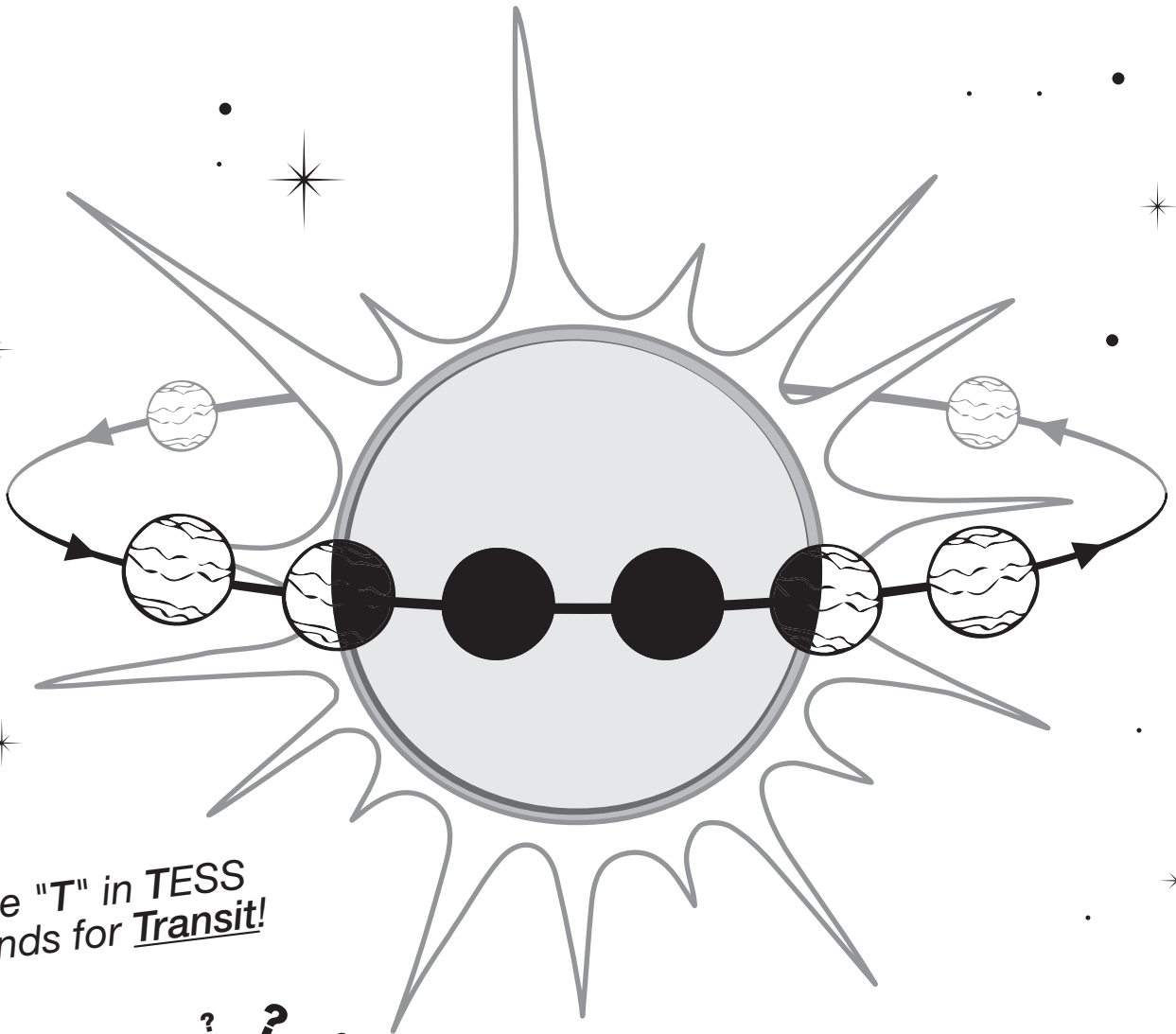

The "T" in TESS stands for Transit!

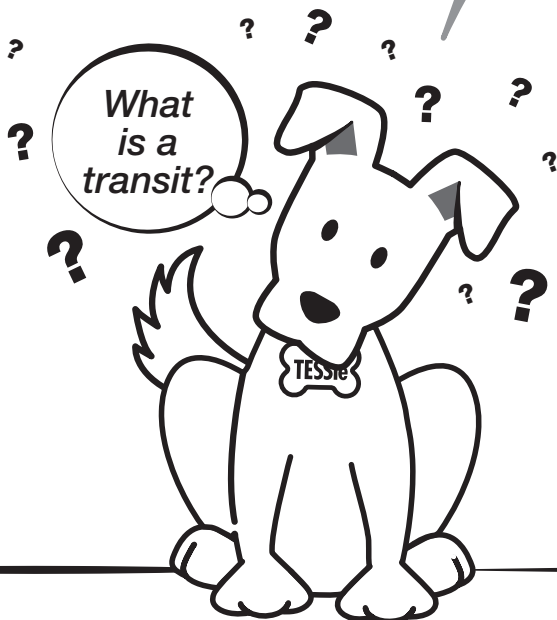

When an exoplanet passes in front of a star, it blocks out some of the light, like a solar eclipse.

We call that "transit!"

The more light that is blocked from a star, the bigger the planet. Scientists can use this information to learn about the type of exoplanet that is discovered.



# PICTURE THIS

*To See Transits, We Need Cameras*

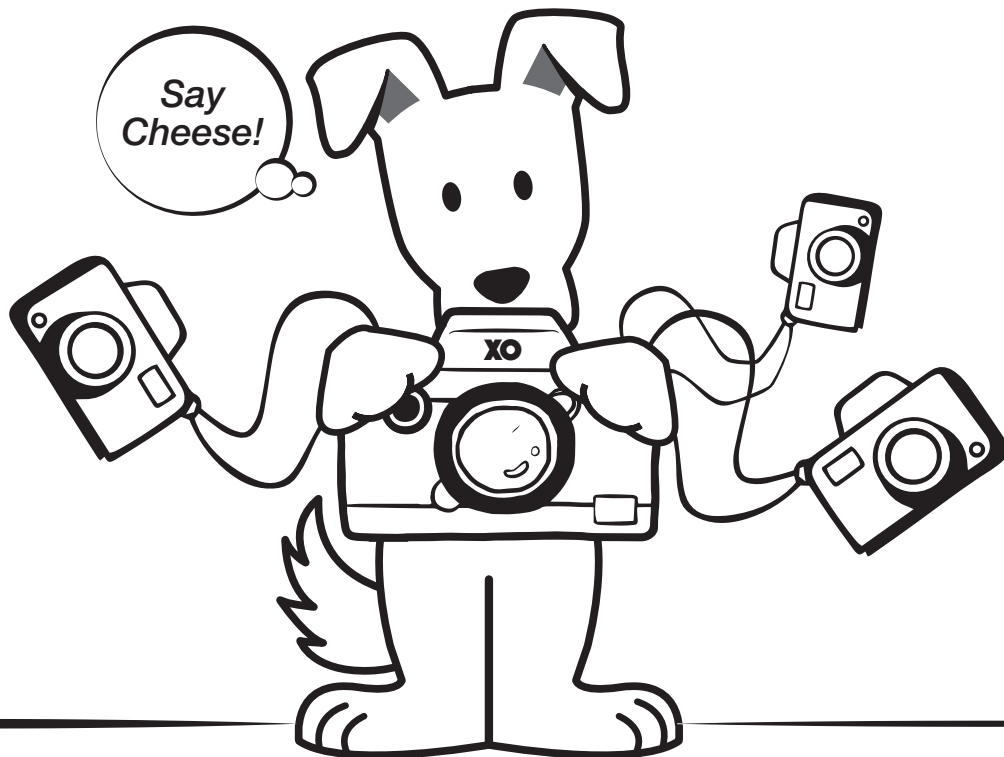
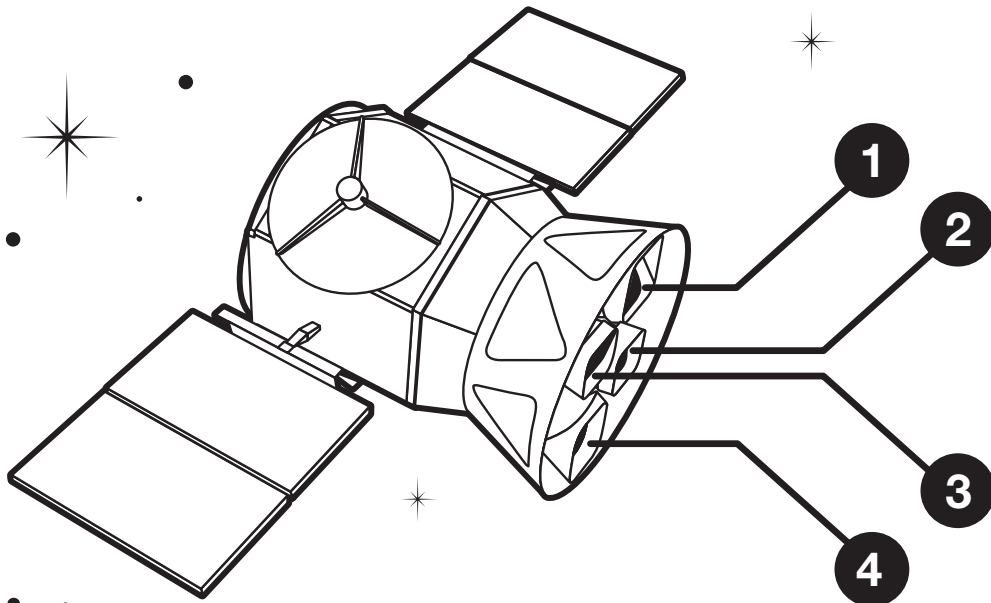

To find exoplanets making transits, we need to take pictures of stars using cameras. TESS will have four cameras on the spacecraft to measure the light of stars.

# THE HISTORY OF EXOPLANET MISSIONS

*The Past and the Future*

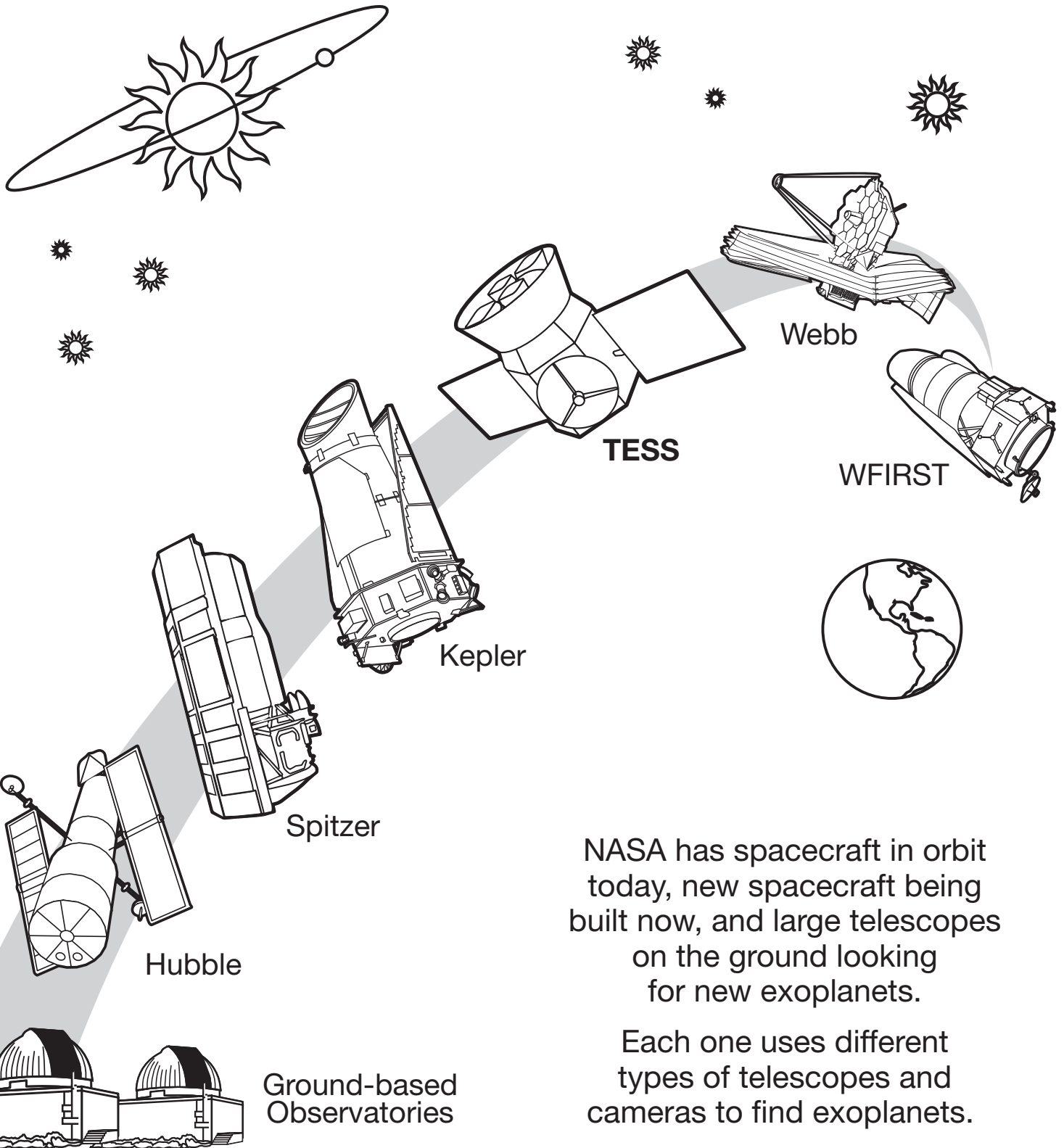

NASA has spacecraft in orbit today, new spacecraft being built now, and large telescopes on the ground looking for new exoplanets.

Each one uses different types of telescopes and cameras to find exoplanets.

# ***THE NEXT EXOPLANET HUNTER***

*Color Our Mission Logo*

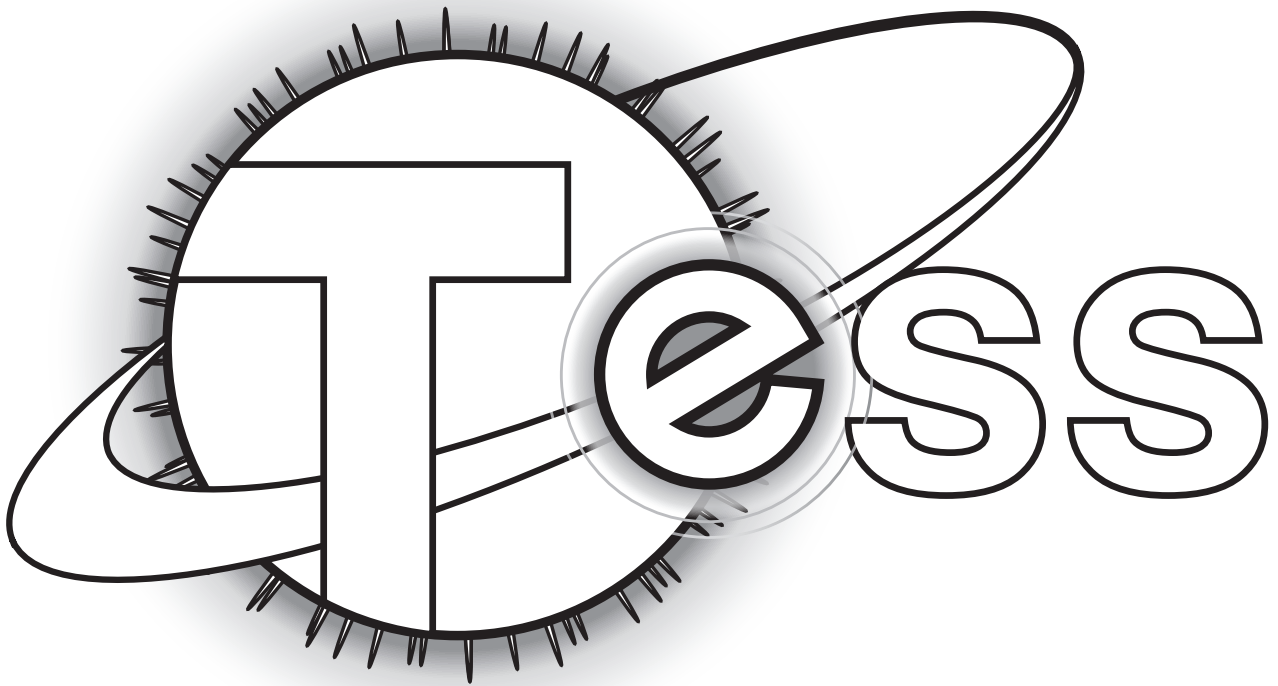

The **Transiting Exoplanet Survey Satellite (TESS)** will use cameras to look for exoplanet transits. TESS will discover thousands of new exoplanets in orbit around the brightest stars in the sky. The exoplanets TESS will find will be closer to Earth where future missions can investigate if they are like Earth.

*<http://tess.gsfc.nasa.gov>*

# **TESS IN COLOR**

*Give the TESS Spacecraft a Touch of Color*

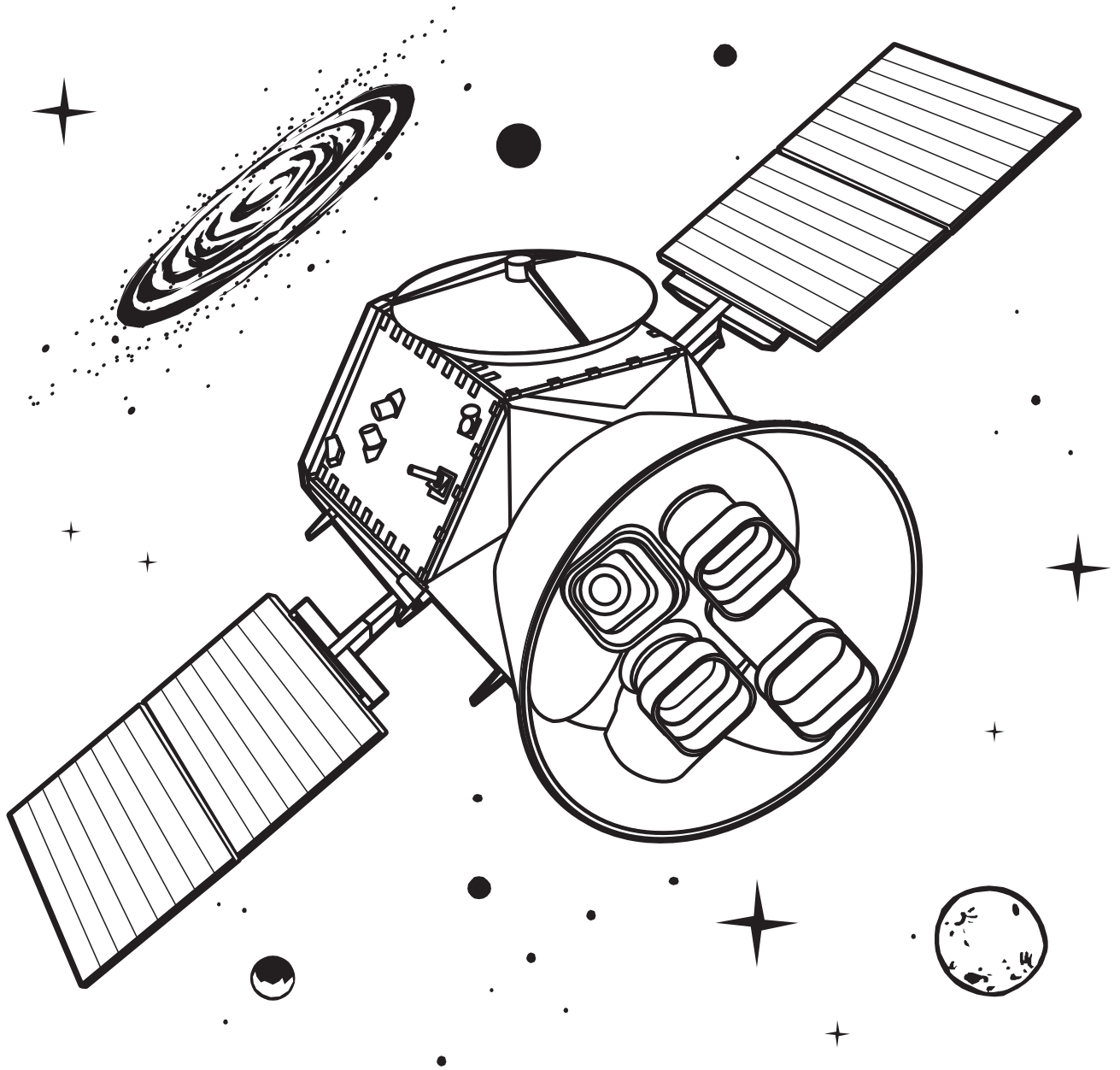

TESS will *survey* (the 1st "S" in TESS) the entire sky looking at 200,000 stars across the whole sky during a two-year mission to find new planets!

# ***DOWNLOADING TESS DATA***

## *How Does Information Get to Us?*

To get the information from space to the scientists on the ground, there are three stages:

- 1** The four TESS cameras gather the exoplanet transit data
- 2** TESS sends the data down to Earth to ground stations in Spain, Australia, and the United States in California
- 3** The data is sent to the scientists at the Massachusetts Institute of Technology (MIT) to look for exoplanet transits

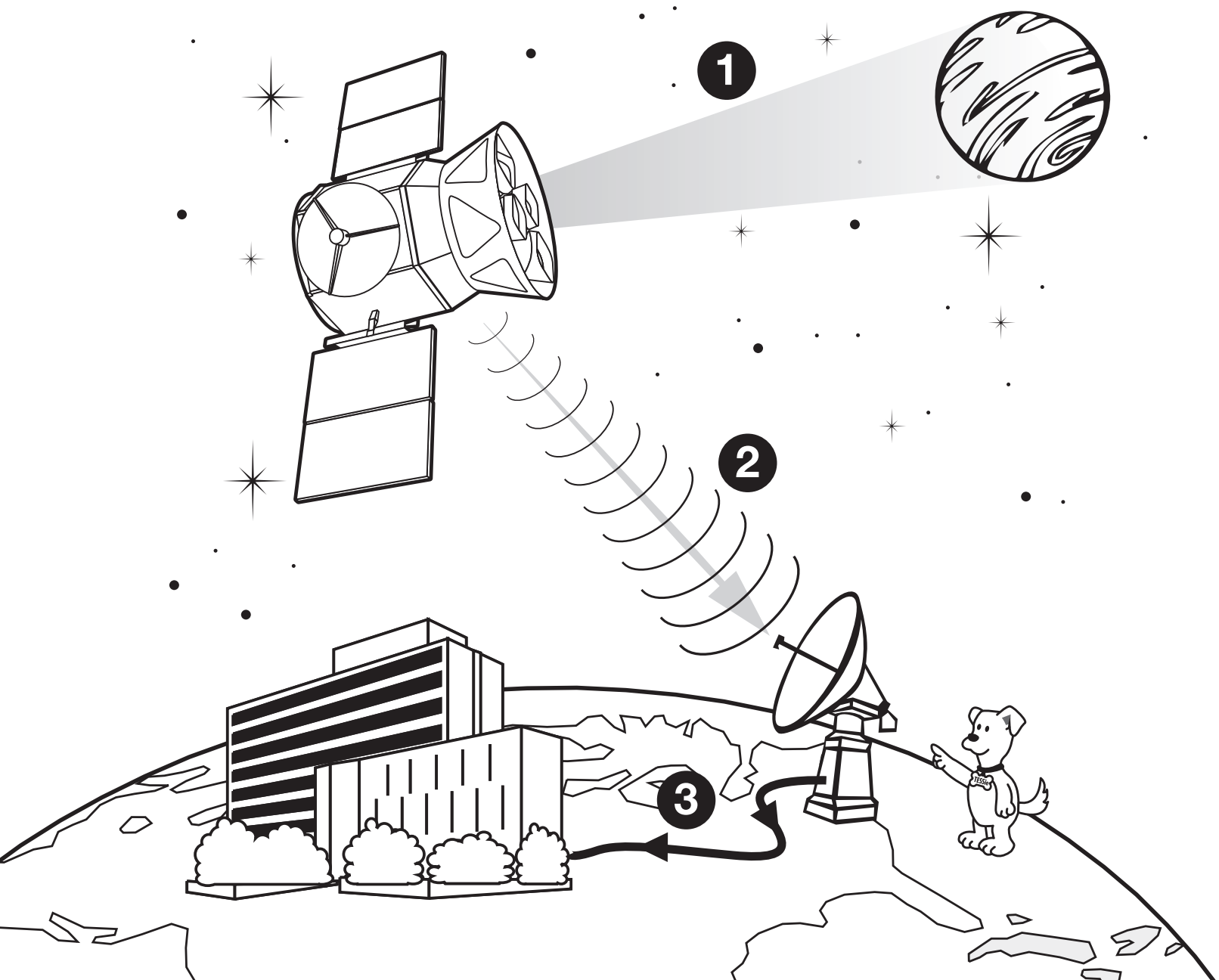

# ***DRAWING TIME***

*What Is Your Favorite Type of Exoplanet? Draw It Below.*

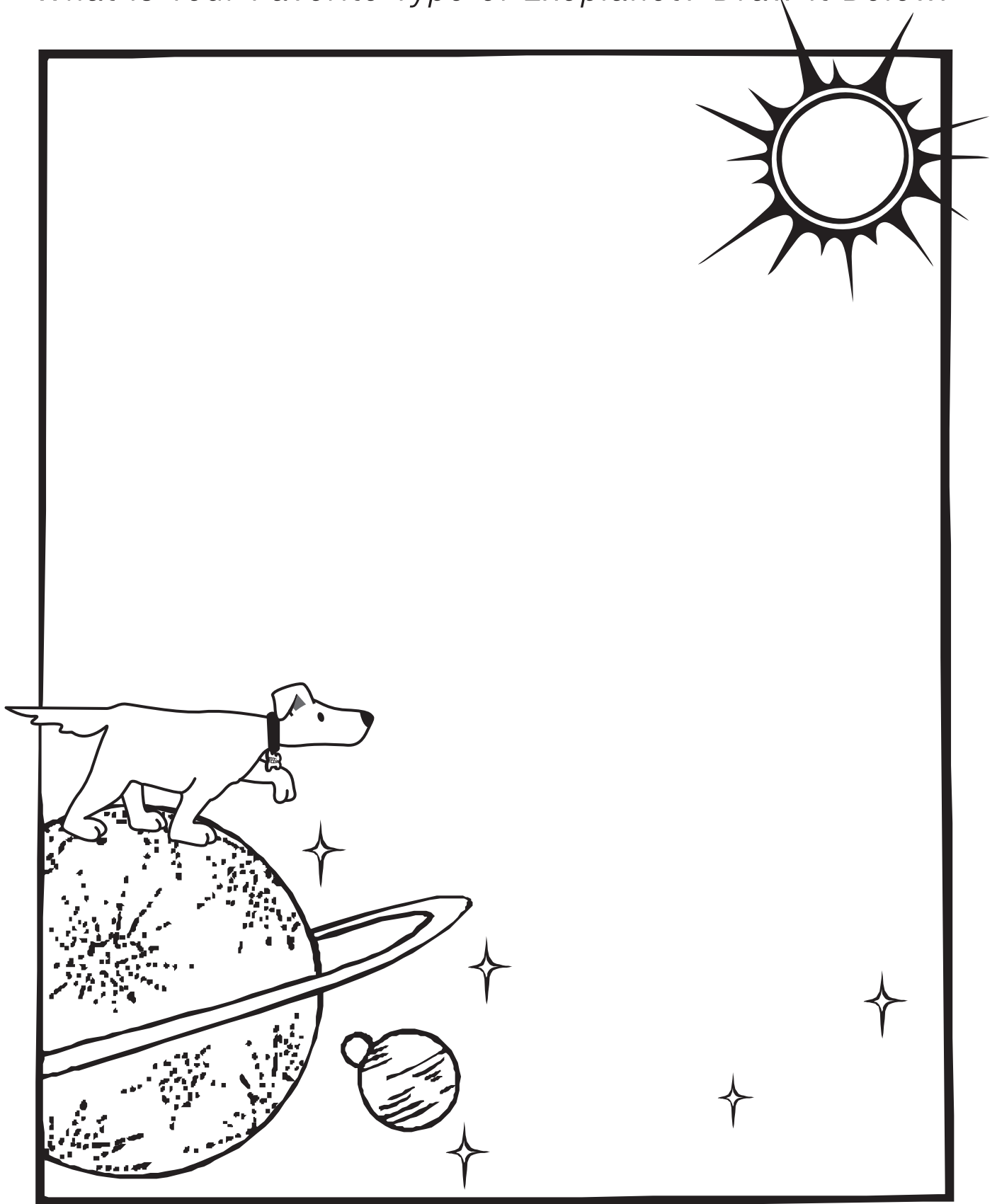

# ***DESIGN A NEW SPACECRAFT***

*Next Exoplanet Hunter Satellite!*



# ***EXPLORING A NEW WORLD WITH TESSIE***

*Draw Yourself Standing on an Exoplanet*

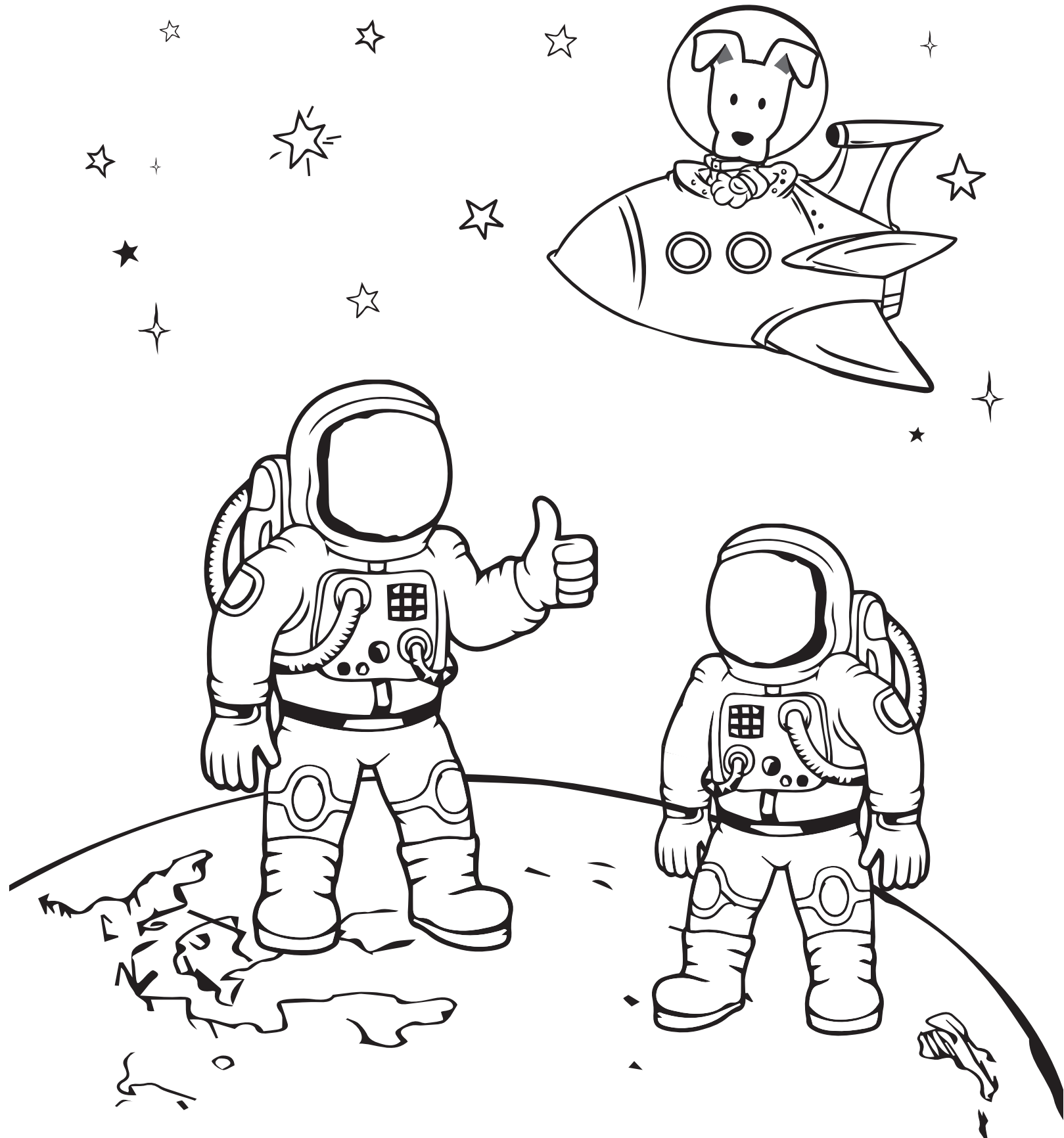



# **EXOPLANET: USE YOUR IMAGINATION**

*Draw as Many Exoplanets as You Can*

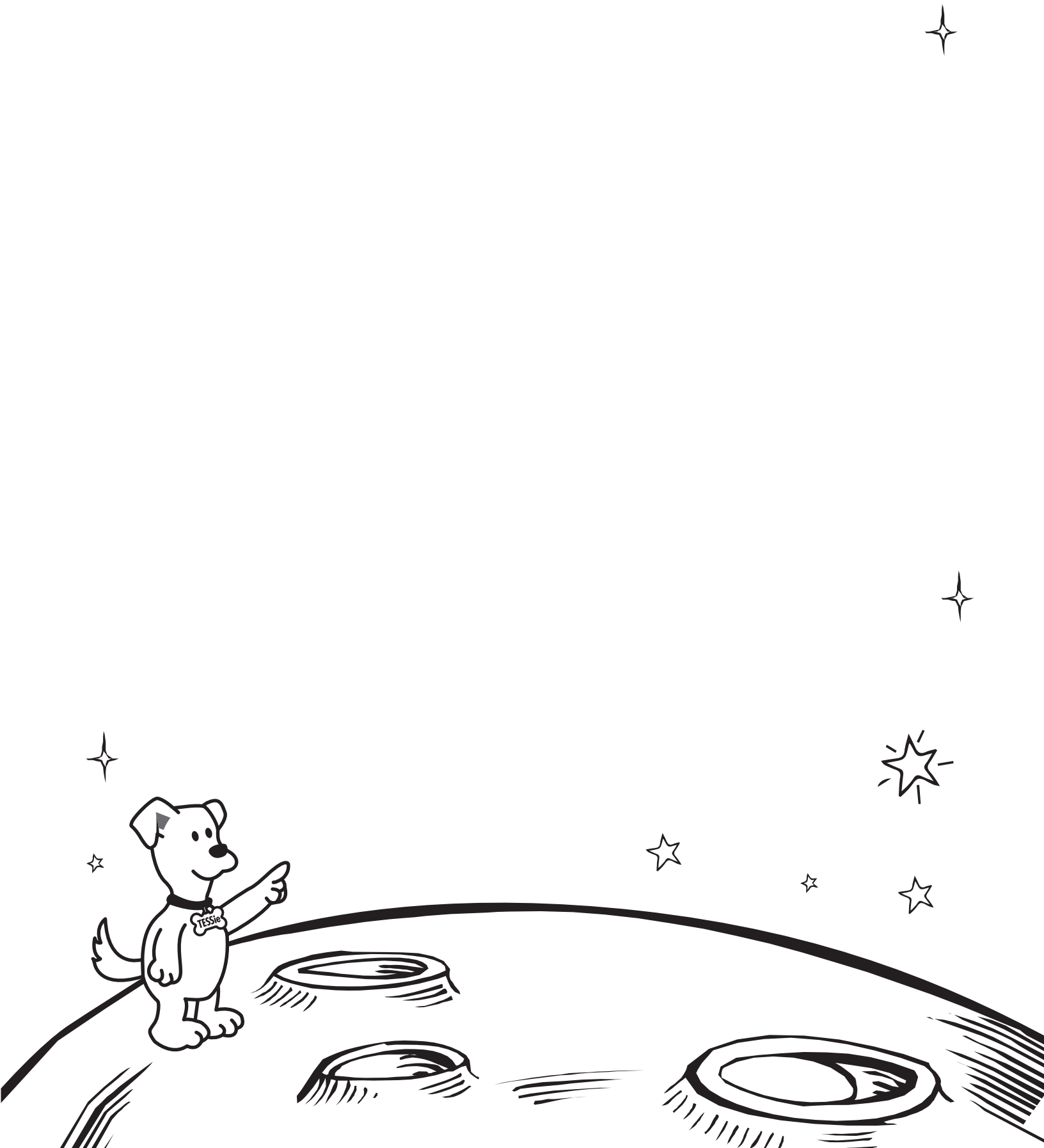

# ***MAYBE ONE DAY YOU'LL HELP US FIND NEW PLANETS?***



TESS will find lots of exoplanets that we will study for years. Join us in learning what is beyond our solar system.

**EXPLORE  
MORE**

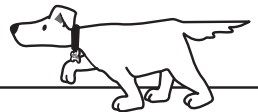

For more information on  
NASA and the TESS mission,  
visit these web sites:

*<http://education.nasa.gov>*

*<http://nasascience.nasa.gov/>*

*<http://tess.gsfc.nasa.gov/>*

*<http://www.nasa.gov>*

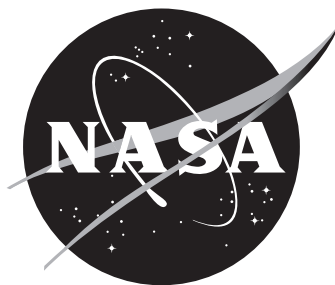

For more information,  
please visit our web site:  
<http://tess.gsfc.nasa.gov/>

Follow us on Twitter and Facebook:  
[https://twitter.com/NASA\\_TESS](https://twitter.com/NASA_TESS)  
<https://www.facebook.com/NASATESS>

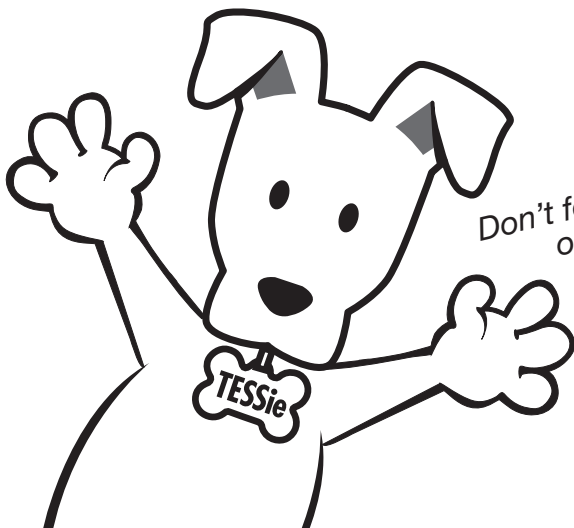

Don't forget to watch  
our launch!