

熱い宇宙の中を観る  
Insight into the Hot Universe

X-ray Astronomy Satellite  
ASTRO-H



国立研究開発法人  
宇宙航空研究開発機構 宇宙科学研究所  
ASTRO-Hプロジェクトチーム  
神奈川県相模原市中央区由野台3-1-1  
042-759-800 8 (宇宙科学研究所 広報・普及係)  
<http://www.isas.jaxa.jp>

ASTRO-Hプロジェクトサイト  
<http://astro-h.isas.jaxa.jp/>



2016.01en

The universe appears to be cold and peaceful, but seen in X-ray, outer space is filled with turbulence in the form of explosions, collisions, and outbursts. For the purpose of advancing astronomical observations in X-rays, the next generation X-ray observatory ASTRO-H was developed from an international collaboration including Japan and NASA. The cutting edge instrument on board is the "X-ray micro-calorimeter," which observes X-rays from space with the world's greatest spectral capability. The other 3 detectors on board allow high sensitivity observations in a wide bandwidth spanning soft X-ray to the softest Gamma-ray. ASTRO-H will apply these new functions to investigate the mechanisms of how galaxy clusters—the largest objects in space made of "visible matter"—formed and influenced by dark energy and dark matter, to reveal the formation and evolution of supermassive black holes at the center of galaxies, and to unearth the physical laws governing extreme conditions in neutron stars and black holes.

- 01 ASTRO-H Science Goals
- 02 ASTRO-H Instruments
- 03 ASTRO-H Overview



What is the hot, energetic universe? What can be learned from observing X-rays in space? Here, the primary ASTRO-H science goals are introduced.

## 1.1 ASTRO-H Science Objectives

By aiming to reveal the structure of the universe and the physics hidden in the hot, energetic universe, ASTRO-H will strive to meet the following science goals.

### Goal 1. Study of the structure of the universe

Galaxy clusters are the largest structures in space (Figure 1.1). Dark matter within these clusters traps X-ray emitting hot plasma with gravity, and measurements of the energies from turbulence, collisions, and shock waves of hot plasma will lead to a more complete understanding of galaxy cluster evolution and energy distribution. In addition, properties of the background dark matter and dark energy will be investigated.

Black holes at the center of galaxies will be observed to reveal the role black holes have played in the formation and evolution of galaxies.

Measuring the properties of various elements including rare metals inside the hot plasma of galaxy clusters will reveal the history of how the current chemical composition of the universe came to be.



Fig. 1.1: Illustration of a galaxy cluster observed in optical light. Several hundred galaxies are concentrated in the center by the gravitational pull of dark matter, where hot plasma that emits X-rays is also present (not illustrated).

### Goal 2. Study of the physics in extreme conditions

By observing neutron stars and black holes (Figure 1.2), ASTRO-H will investigate the physics of conditions that cannot be reproduced on Earth, such as high temperature, strong gravitational and magnetic fields, and extremely dense regions, and probe the laws of physics in the background such as the distortion of relativistic space-time.

By identifying and observing the regions where particles are accelerated almost to the speed of light and achieve high energies such as pulsars, supernova remnants, black holes, and galaxy clusters, ASTRO-H will probe the physical processes therein.

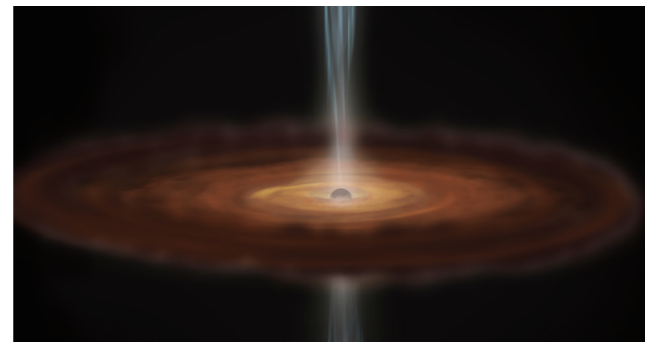

Figure 1.2: Illustration of a black hole. Not only are X-rays emitted by matter accreted by black holes, they are also emitted when a fraction of the accreted matter is beamed out.

## 1.2 More to space than meets the eye

Planets, stars, galaxies, and galaxy clusters are visible when the universe is observed in visible or optical light. However, this accounts for only a fraction of the universe. For example, observations of objects in X-rays (Figure 1.3) reveal a much different picture. The X-rays emitted by the sun and galaxy clusters are from hot plasma, and the Crab Nebula and Jupiter produce high energy particles that emit X-rays. The total mass of hot plasma that emit X-rays surpasses the total mass of all stars.

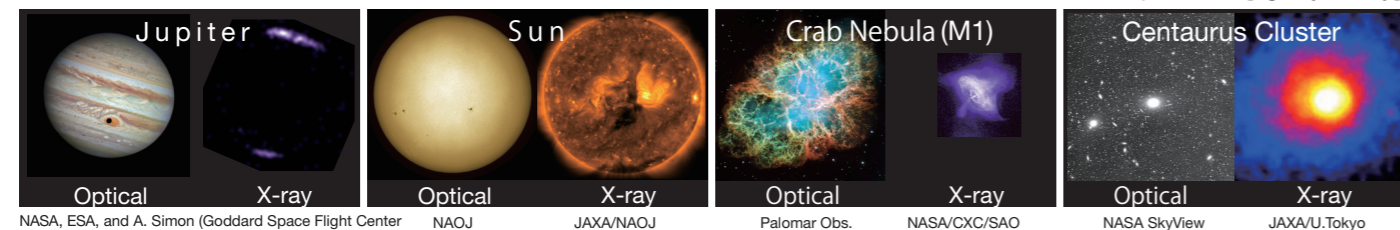
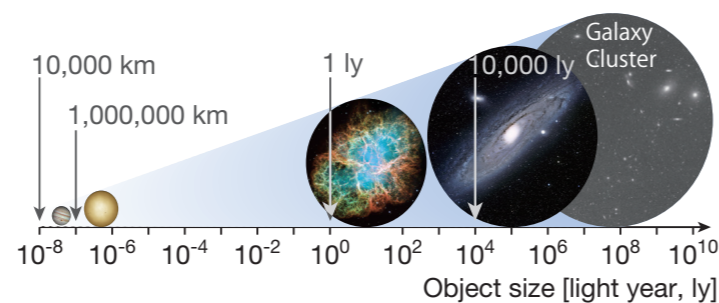

Figure 1.3: Size comparison of various sources (above), and their images in optical light and X-ray.

## 1.3 The universe observed in X-rays

ASTRO-H will observe the universe in the X-ray band. X-rays are one type of light (electromagnetic spectrum), and as shown in Figure 1.4, X-rays range in wavelengths from 1/10,000 to 1/100,000 of optical wavelengths. A single X-ray photon has from 10,000 to 100,000 times the energy of optical photons. Photon energies are commonly expressed in units of kilovolts (keV), and the energy is inversely proportional to the wavelength. The advantages of observing in X-rays are summarized in 4 points below.

### 1.3.1 Ability to detect more material

X-ray emitting hot plasma exist in larger quantities than stars, and account for 80% of “observable” matter. Therefore, using the powerful tool of X-ray detectors, the majority of the observable universe is detectable.

### 1.3.2 Ability to identify regions of concentrated energy

As people radiate in infrared at around 36 degrees Celsius, and the Sun mostly emits in visible light at 6,000 degrees, the higher the temperature of an object, the shorter the wavelength of the emitted light. X-rays are radiated from particles accelerated to high energies, and extremely hot plasmas of several million to several tens of millions of degrees. Regions with high concentrations of energy such as high temperature, strong gravity, fast rotation, violent collisions, explosions, strong magnetic fields, and nuclear reactions can be selectively observed using X-rays.

### 1.3.3 Advantage of highly penetrative power

As one can see from the example of the X-ray image (Figure 1.6), X-rays have high penetrating power. Even if an X-ray source is enveloped in a dense material such as a molecular cloud, X-rays can penetrate through the material. Diamonds are clear, and charcoal is black, but they are both made of the same carbon. The transparency in visible light depends on the chemical structure, but X-ray transmissivity does not depend on the chemical composition.

### 1.3.4 Measuring chemical composition

When table salt is added to a candle flame, the light becomes yellow. The color is a reaction caused by the strong radiation of the wavelength characteristic of that element (yellow is from sodium), and is called flame reaction. A similar reaction occurs in the X-ray. Each element radiates a specific wavelength, so measuring the strength of a given wavelength reveals the quantity of specific elements. Figure 1.7 shows images of Cassiopeia A, a supernova remnant, in specific X-ray wavelengths: the oxygen, iron, and calcium. The distribution of various elements can be studied from wavelength specific images.

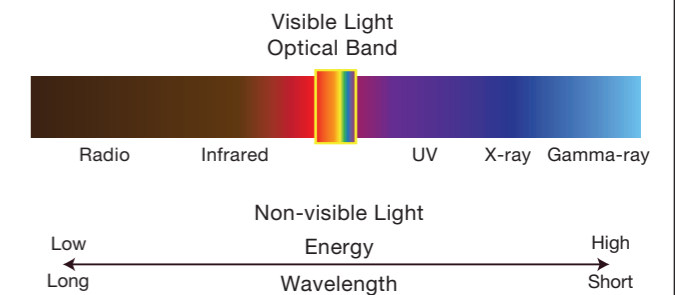

Figure 1.4: Electromagnetic spectrum in energy and wavelength

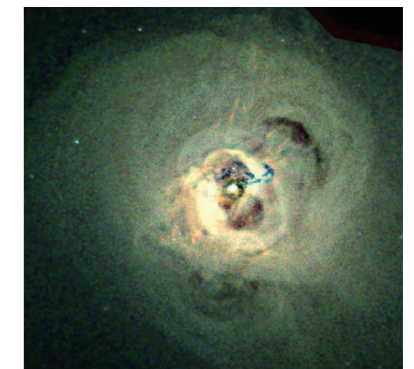

Figure 1.5: Center of Perseus galaxy cluster (NASA/CXC/IOA/Fabian et al.)



Figure 1.6: Example of X-ray image

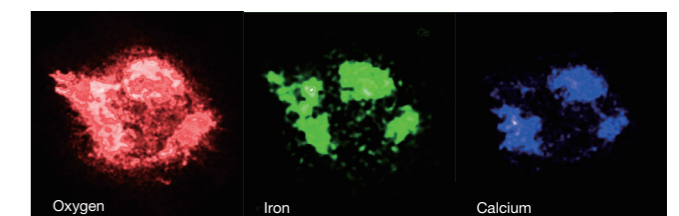

Figure 1.7: Distribution of various elements in supernova remnant Cassiopeia A. (NASA/GSFC/U.Hwang et al.)



## 1.4 History of X-ray Astronomy and ASTRO-H

### 1.4.1 Reasons for observing outside of Earth's atmosphere

X-rays can penetrate through human bodies, but as seen in Figure 1.8, X-rays from space cannot penetrate Earth's atmospheric barrier and reach observatories on the ground. This is because Earth's atmosphere has 50 times more atomic density (approximately  $10^{25}$  per  $\text{cm}^2$  from the ground to the sky) compared to a human body of which an X-ray is taken. Therefore, in order to observe X-rays from space, it is necessary to use satellites outside of Earth's atmosphere. ASTRO-H will observe astronomical sources from an orbit at an altitude of 575 km.

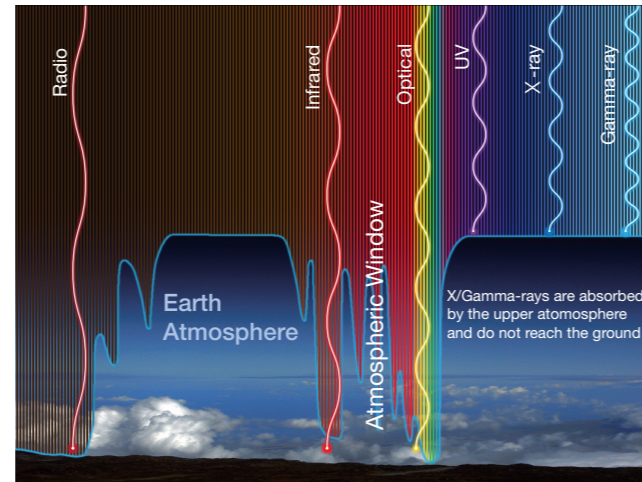

Figure 1.8: Atmospheric transmission and lights with various wavelength. Atmospheric window is a wavelength band where light is less absorbed by the atmosphere and can reach the ground.

### 1.4.2 Birth of X-ray astronomy and the present

X-ray astronomy is a young field that began with the coincidental discovery of the strongest X-ray source "Scorpius X-1" during a rocket flight in 1962. Since that discovery scientists have learned that many astronomical objects emit X-rays, including planets, neutron stars, black holes, supernova remnants, galaxies, and galaxy clusters. During this time, Japan has developed numerous X-ray instruments to keep up with improvements in rocket performance and advancements in satellite technology. The sequence of the 5 X-ray astronomy satellites led by Japan is shown in Figure 1.9: Hakucho (1979), Tenma (1983), Ginga (1987), ASCA (1993), Suzaku (2005). Results that are most notable from Japan's satellites include the strengthening of observational evidence that supports the existence of black holes, the discovery of direct evidence that cosmic rays are accelerated in supernova remnants, the spatial distribution of heavy elements inside the plasma of galaxy clusters, and the precise magnetic field measurements of neutron stars. The hot and violent universe has gradually revealed itself this way, but it has also raised more fundamental questions about the structure of the universe. These are the challenging goals discussed in section 1.1 that ASTRO-H will aim to achieve.

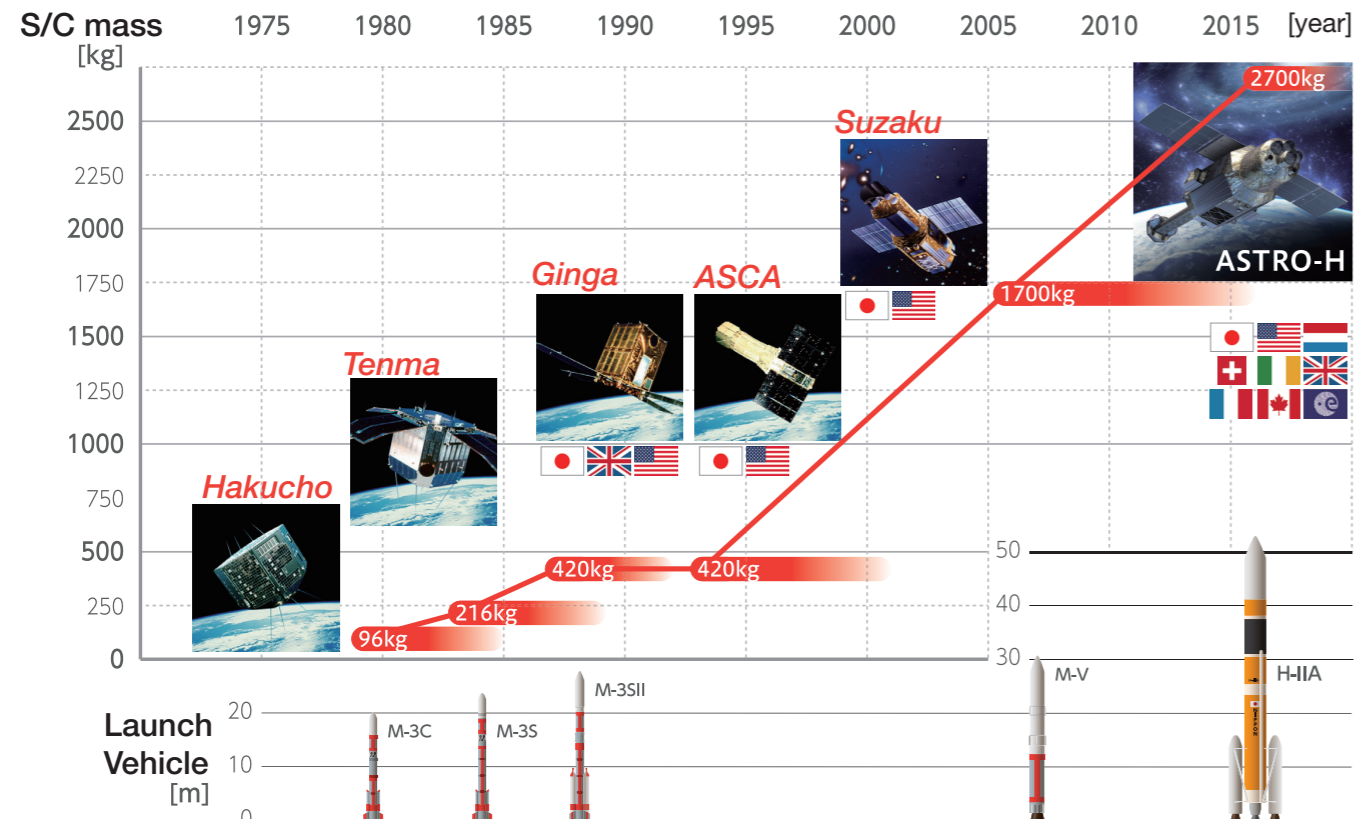

Figure 1.9: The history of X-ray astronomy in Japan. The satellite mass and the rocket used for launch are presented as a function of time at which the launch occurred. The flags represent the participating countries. Satellite size and performance has evolved to match the advancement of rockets. This has also led to the broadening of international participation.

## 1.5 ASTRO-H features

Figure 1.10 compares the characteristics of ASTRO-H with other major international X-ray observatories. Although the image resolution of ASTRO-H is surpassed by other satellites, ASTRO-H was designed with the main focus on the microcalorimeter detector, which can measure the energy of X-rays with high resolution, and the ability to make measurements with multiple detectors that cover a broad energy range simultaneously. The following describes these features in detail.

### Feature 1: Ability to measure X-ray photon energies with high resolution

With the ability to measure X-ray photon energies with 30 times higher resolution than previous detectors, the ASTRO-H microcalorimeter is expected to gather an abundance of invaluable data such as the following.

**Chemical composition:** With the ability to measure weaker or "soft" X-rays (see Figure 1.11), ASTRO-H will be able to detect aluminum, sodium, and other rare metals, in addition to more common elements such as oxygen and iron, providing a more complete picture of the abundance of elements in space.

**Motion:** If an object is moving along the line of sight, the X-ray photon energies shift due to the Doppler shift. The microcalorimeter can accurately measure the small energy shifts better than previous devices, making it possible to measure for the first time the expansion speed of supernova remnants, the collision speed of galaxy clusters, and the speed of shock waves and disturbances generated by the collision of plasma. These will allow for a closer estimate of the kinetic energies of astronomical sources.

**Strong gravity:** X-ray energies emitted from matter accreted by black holes produce a "gravitational redshift." A better understanding of space-time distortion near black holes can be gained from this measurement.

### Feature 2: Ability to observe a broad energy range with multiple instruments simultaneously

The multiple detectors on board ASTRO-H observe the same object simultaneously, and they are able to collect data that span a wide range in energy, from 0.3 to 600 keV. As a result, ASTRO-H is expected to achieve advancements in astronomy by making it possible to obtain measurements of extremely hot plasma temperatures that could not previously have been determined, to detect supermassive black holes at the center of galaxies surrounded by dense gas (see Figure 1.12), and to study the acceleration of particles near supernova remnants and neutron stars that spin at extremely high speeds. It may also be possible to find evidence that positrons are created near neutron stars and black holes.

### Highly anticipated ASTRO-H

ASTRO-H is a joint project with JAXA (Japan Aerospace Exploration Agency) and NASA (National Aeronautics and Space Administration) as the principal partners. Led by Japan, it is a large-scale international collaboration, boasting the participation of 8 countries including the United States, the Netherlands, and Canada, with additional partnership by ESA (European Space Agency). After launch, proposals for observations will be accepted from all over the world. As the sole large-scale public X-ray observatory, ASTRO-H will offer over 10 years of data to the public, and is highly anticipated by researchers who wish to understand "the physics of the hot universe."

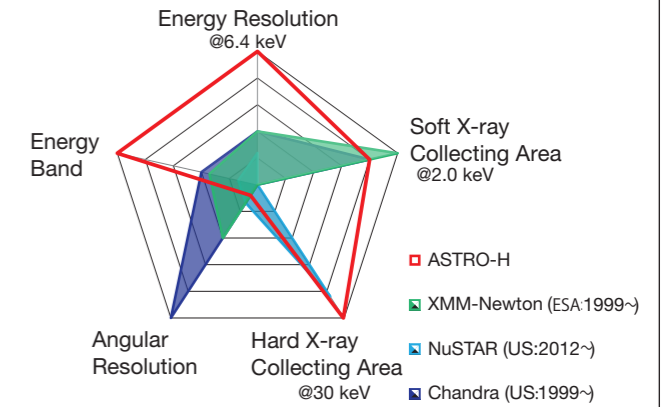

Figure 1.10: Comparison of X-ray Astronomy Satellites

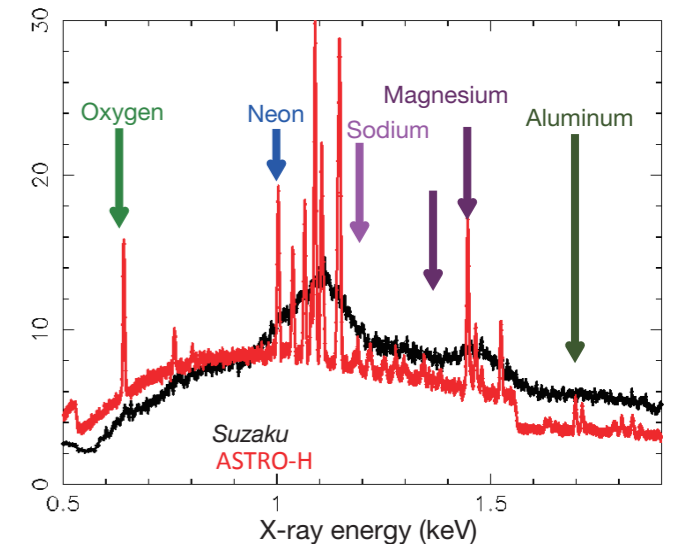

Figure 1.11: X-ray spectra from the Perseus cluster. Suzaku data is from a real observation. ASTRO-H data is a simulation and allows us to detect emission lines from rare elements, such as sodium, aluminum, and to determine abundances accurately.

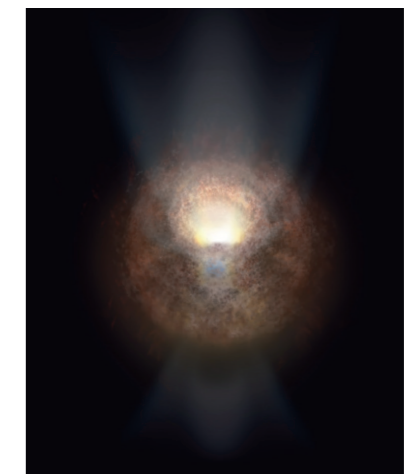

Figure 1.12: Illustration of a black hole illuminating the surrounding dense gas (Artist: Akihiro Ikeshita)



## 1.6 Mysteries to be investigated by ASTRO-H

### 1.6.1 Investigate the structure of the universe

#### How do black holes develop, and how do they impact their surroundings?

Black holes that range from a few hundred to 100 million times the mass of the sun reside at the center of almost all galaxies. However, how black holes were created and developed during the 13.8 billion year history of the universe has long been a mystery. ASTRO-H will search for supermassive black holes as far away as 8 billion light years away, and by understanding their quantity and following their time variation in X-ray strength, it will be possible to investigate how supermassive black holes developed from the surrounding gas and whether it is possible for them to have grown by repeated collisions.

Black holes not only accrete surrounding matter, they also eject matter outside of their galaxies. In particular, active supermassive black holes still in their early development are likely to strongly influence the evolution of galaxies and galaxy clusters, which is the equivalent of an orange-sized object having a significant effect on Earth. By making measurements such as the amount of gas accreted by black holes, the flow rate and speed of matter being ejected from black holes, it will be possible to make a closer and more direct estimate of the effect that supermassive black holes have on galaxies and galaxy clusters.

#### How are galaxy clusters created, and how do they evolve?

Galaxy clusters are the largest structures in the universe. All galaxy clusters appear to be a cluster of galaxies in the optical, but hot plasma observable in X-ray account for many times the mass, and dark matter which totals 5 times the mass of "observable" matter is also present. Utilizing the Doppler effect of X-rays, it will be possible to measure the dynamics of plasma with ASTRO-H. Physical parameters such as kinetic energy and dark matter mass can be calculated, and by comparisons with computer simulation, a clearer understanding of how galaxy clusters were created, interact, and evolve will become attainable.

#### When were heavy elements in the universe created, and how much?

Shortly after the beginning of the universe, there were only 3 elements: hydrogen, helium, and lithium. After that, close to 100 heavy elements were created from the inside of stars and supernovae, including carbon, oxygen, iron, and gold. Since then, the universe evolved into its current diverse state including planets and lifeforms. By observing supernova remnants which are the main birth places of heavy elements, and galaxy cluster plasma which have high concentrations of heavy elements, measurements of X-ray strengths of various heavy elements including rare metals such as chromium and manganese can be made which will allow a better understanding of where, when, and how much of these elements were created.

### 1.6.2 Investigation and discoveries of physics at extreme conditions

#### What physical phenomena are occurring in extreme conditions with high density and strong magnetic fields?

Sources called neutron stars and white dwarfs offer windows into extreme conditions of high density and strong magnetic fields that cannot be found on Earth. In such extreme conditions, peculiar phenomena are thought to occur such as superfluidity of protons due to high density, and the splitting of photons caused by strong magnetic fields. By observing the emitted X-rays and soft gamma rays originating from these extreme regions, the laws of physics controlling such phenomena can be more thoroughly defined and understood. Furthermore, the possibility of new laws that surpass the currently understood laws of physics may be investigated.

#### Is space time really distorted near black holes?

It has been more than 50 years since the beginning of X-ray astronomy. Evidence from various studies now strongly support that X-ray sources such as Cygnus X-1 are black holes accreting gas from companion stars, and that supermassive black holes 100 millions times as massive as the Sun exist at the center of galaxies. However, we have just reached a new era where it has become possible to directly observe the distortion of space time as predicted by Einstein's theory of general relativity, and investigate whether the observed distortion can be used to investigate the rotation of black holes. ASTRO-H will take on these challenging topics by observing the dynamics of the gas accreted by black holes.

#### Where and how are cosmic rays created?

It has been roughly 100 years since the discovery of cosmic rays, high energy particles that travel at 99.9999...% (10-20 trailing 9s) the speed of light. From observations with ASCA and Suzaku, it has become more evident that supernova remnants are the sources of cosmic rays. However, the structure of how these cosmic rays are accelerated is still unclear. Furthermore, the acceleration sites for the cosmic rays with the highest energies in particular have not yet been identified. By observing supernova remnants in broad range X-ray, ASTRO-H will endeavor to reveal the acceleration mechanism of cosmic rays, and investigate the possibility of supermassive black holes and galaxy clusters are the sources of high energy cosmic rays.



# ASTRO-H Instruments

Introduction of the subsystem instruments on board ASTRO-H, and how each instrument will contribute to unraveling the hot, violent universe. ASTRO-H carries the most leading edge X-ray instruments and the satellite technology that will implement their successful operation.

## 2.1 Instrument Positions on Spacecraft

The 4 telescopes and 2 soft gamma-ray detectors face the same direction, and are capable of observing simultaneously. The 4 types of detectors (6 systems) detect X-ray photons from space one at a time.

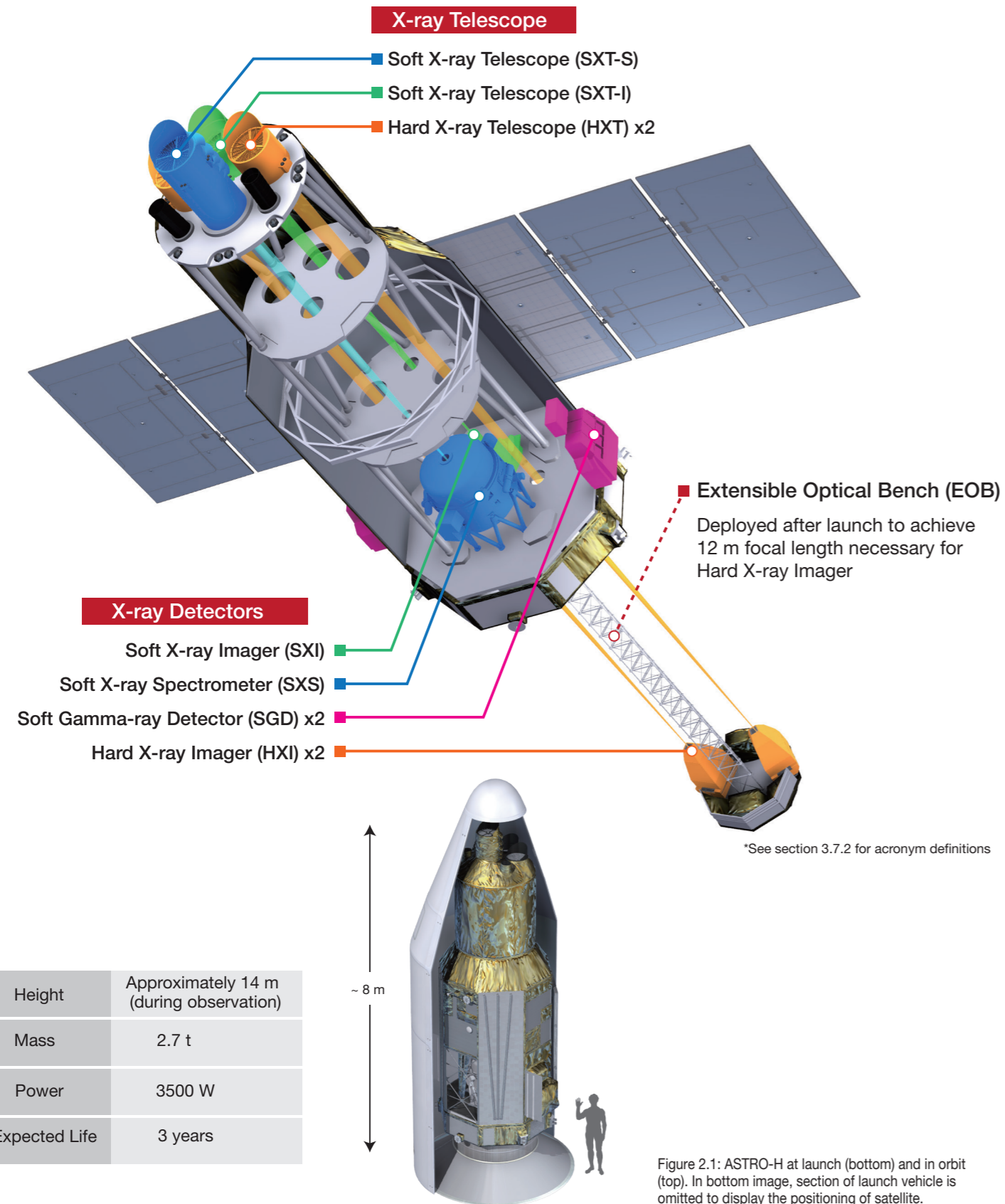

Figure 2.1: ASTRO-H at launch (bottom) and in orbit (top). In bottom image, section of launch vehicle is omitted to display the positioning of satellite.

## 2.2 Two Telescopes and Four Detectors

There are 2 types of telescopes, and 4 types of detectors with various features on board ASTRO-H.

<p><b>Soft X-ray Telescope (SXT-S)</b> Soft X-ray Telescope (SXT-I)</p> <p>X-ray telescope that corresponds to the lens of the optical telescope. Unlike the optical case, the X-ray telescope is structured with over 200 aluminum shells that reflect X-rays concentrically aligned. The diameter is 45 cm, focal length 5.6 m.</p>	<p><b>Hard X-ray Telescope (HXT) x2</b></p> <p>Same structure as soft X-ray telescope, has the ability to image hard X-rays up to 80 keV using Japanese nano technology. 45 cm diameter, 12 m focal length.</p>
<p><b>Soft X-ray Spectrometer (SXS)</b></p> <p>Uses US-led technology called microcalorimetry. Includes multiple stages of coolers to lower the temperature of the sensor to near absolute zero (-273.15 degrees C). By measuring the slight increase in temperature from incoming X-ray photons, it is capable of measuring the X-ray energy in never before achieved high resolution. The most highly anticipated device on ASTRO-H by scientists.</p>	<p><b>Soft X-ray Imager (SXI)</b></p> <p>X-ray camera that achieves wide field of view of 38 arcmin by arranging 4 large X-ray CCDs together. Simultaneously implements X-ray imaging and spectrometry of sources in soft X-ray band. Located inside the satellite at the focal plane of SXT-I.</p>
<p><b>Hard X-ray Imager (HXI) x2</b></p> <p>Camera that observes sources in hard X-ray with energy 5 keV and higher using silicon and Cadmium Telluride semiconductors. Located at the focus of the HXT with 12m focal length, which is realized by the extensible optical bench (EOB) that gets deployed in orbit.</p>	<p><b>Soft Gamma-ray Detector (SGD) x2</b></p> <p>High sensitivity gamma-ray detector layered with semiconductor detectors and using Compton camera theory. Cannot image sources since it does not use a telescope, but anticipated to reveal high energy phenomena by detecting soft gamma-rays with higher energy than X-ray.</p>

ASTRO-H is capable of observing a wide energy range of 0.3 - 600 keV by uniting the multiple observing instruments above. The detector sensitivity achieves 10 to 100 times that of Suzaku as shown in Figure 2.2.

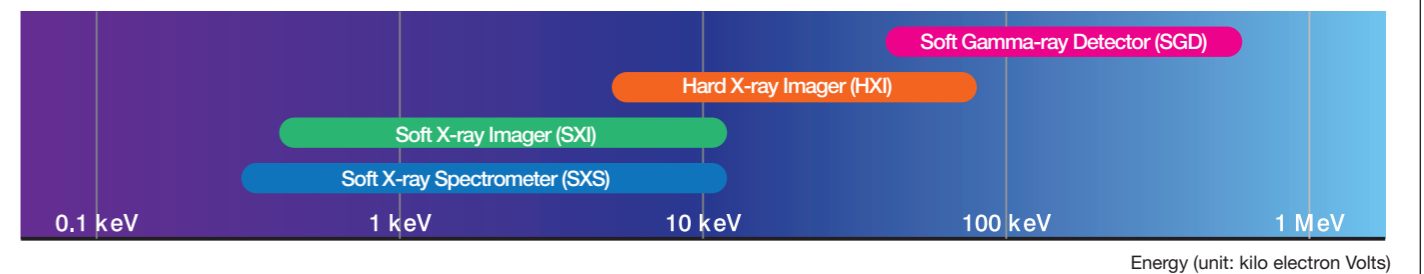

Figure 2.2: Energy range of the 4 detectors on ASTRO-H



## 2.3 ASTRO-H Technology

### 2.3.1 X-ray Telescopes with focusing capability (SXT, HXT)

These can focus X-rays with energy up to 8 times higher than Suzaku.

An X-ray telescope collects X-rays from the cosmos, just like an optical telescope collects visible light. However, a similar lens or mirror cannot be used to focus X-rays because of the high transmittance of X-rays. Instead, X-rays can be reflected when they are incident on a very smooth surface at a shallow grazing incidence angle, 1 deg or less, just like a stone skimming on water. Using this property, the X-ray telescope focuses X-rays.

#### Soft X-ray Telescope (SXT-S, SXT-I)

The Soft X-ray Telescopes developed in the United States are made of thin conical shells concentrically aligned, with gold coating on their inner surface. SXT can focus X-rays up to 12 keV.

#### Hard X-ray Telescope (HXT)

The Hard X-ray Telescope employs multilayered coating on its shell surface fabricated by Japanese nanotechnology, with each layer being just a few nanometers thick. The multilayered coating can reflect higher energy X-rays, which cannot be done with a single gold layer surface. Many of X-ray telescopes launched until now were sensitive only for X-rays with energies below ~10 keV, but the HXT can focus X-rays up to 80 keV.

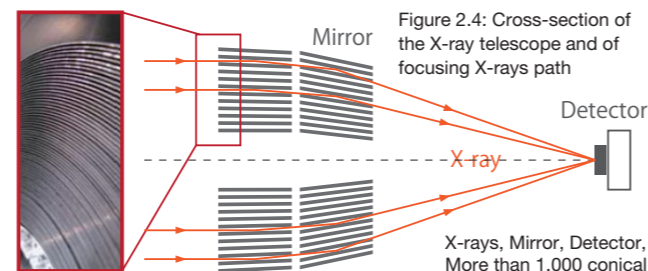

Figure 2.3: A zoomed in image of the telescope aperture

#### Alignment Measurement System (AMS)

The focal length of the HXT is 12 m, which requires precise alignment between the HXT and the HXI. The alignment measurement system can measure small distortions of the EOB by shooting a laser to a retro reflector at a distance of 12 m from the HXT, and provide feedback to the image reconstruction. The AMS was developed in Canada.

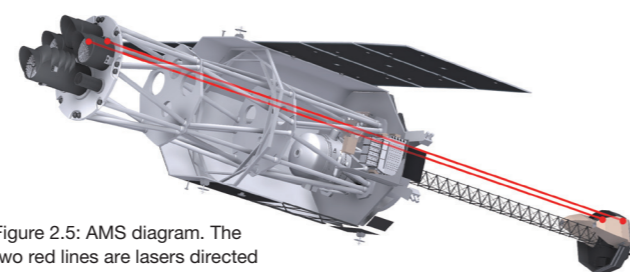

Figure 2.5: AMS diagram. The two red lines are lasers directed to-and-from the retro-reflector

### 2.3.2 High Resolution Soft X-ray Spectrometer (SXS)

#### Capacity to spectrally observe with 30 times the prior resolution

In X-ray observations, spectroscopy — measurement of individual X-ray photon energies—is a very powerful procedure. On ASTRO-H, the Soft X-ray Spectrometer (SXS) is anticipated to achieve 30 times the spectral energy resolution of previous detectors, and lead to new views of the universe.

#### Microcalorimeter

The principle behind the microcalorimeter is very simple. When matter absorbs X-rays, the X-ray photon energies are converted to heat. By precisely measuring the resulting thermal increase, the energy of a single photon can be found. However, this thermal difference is incredibly small, and requires that the detector be cooled to near absolute zero. This technology began being developed in the 1980s led by the U.S. and will finally perform observations for the first time in orbit aboard ASTRO-H.

#### Cooling system

One of the many challenges of realizing the success of micro-calorimeters in space is the cooling technology. The cooling system onboard ASTRO-H was developed in Japan and the U.S., and is capable of high-cooling-performance while being compact. By combining multiple layers of vacuum thermal containers called dewars, multiple stage coolers, and liquid Helium, the cooling system efficiently achieves extremely low temperatures (0.05 K) and is capable of continuing over 3 years of operation.

Figure 2.6: Sensor of SXS micro-calorimeter. The sensor itself is a 5 mm sided square split into a 6x6 array of 36 pixels. Field of view is approximately 3 arcmin.

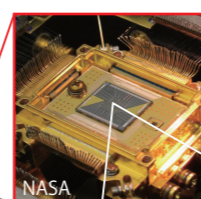

Figure 2.7: Diagram illustrating micro-calorimeter. Measures increase in temperature due to X-ray absorption.

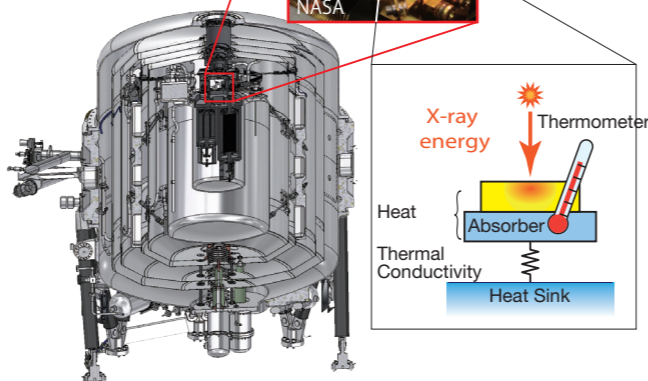

Figure 2.8: Cross-sectional diagram of SXS cooling system

#### Filter Wheel (FWM)

When the X-ray source is too high for SXS, the filter wheel system adjusts the intensity appropriately using multiple types of filters. It also contains an X-ray generator to perform calibration of X-ray spectral energy observation. Development was led by the Netherlands and Switzerland.

### 2.3.3 Detectors with Japanese Semi-conductor Technology (SXI/HXI/SGD)

Observes sources 10 to 100 times fainter than Suzaku

#### Soft X-ray Imager (SXI)

Boasts the widest field of view ever boarded on an X-ray astronomy observatory among CCD cameras. Adopts newly developed Japanese X-ray CCD. Achieved compact size and energy efficiency by converting analog read-out circuits to Large Scale Integration.

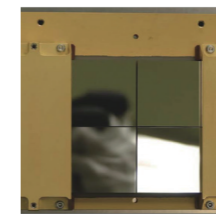

#### Hard X-ray Imager (HXI)

Japan's own new model detector developed for the purpose of high energy X-ray and Gamma-ray imaging. Adopts double-sided strip detector with Silicon and Cadmium Telluride (CdTe) semiconductors.

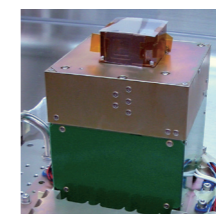

#### Soft Gamma-ray Detector (SGD)

Device that applies the Japanese concept of "small field Si/CdTe multi-layered semiconductor Compton camera" to ASTRO-H. Will have the ability to observe sources in the soft Gamma-ray band with world's highest sensitivity.

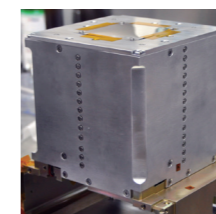

Figure 2.9: Sensor part of each semiconductor detector. In order from top: SXI, HXI, and SGD.

Similar to optical imagers, the ASTRO-H X-ray imagers (SXI, HXI) gather X-rays from sources and produce corresponding images. The principle theory is not very different from a common digital camera. Multiple small semiconductors are arranged in series, which converts X-rays to electrons then to electrical signals that produce the final image. For optical light, one electron is emitted per photon. However, in the case of X-rays, due to the high energies of X-ray photons, multiple electrons are emitted for each X-ray photon. As a result, it is possible to measure the energies of individual X-ray photons. In addition to SXI which incorporates a current CCD, ASTRO-H is equipped with HXI which uses compound semiconductors, allowing the imaging and spectroscopy of higher energies with 100 times the sensitivity of Suzaku.

The Compton camera which is the principle part of SGD is composed of 112 semiconducting imaging sensors per camera. By recording the positions and energies of the incoming X-rays onto SGD, the direction of origin and the energies of the gamma-rays can be found. When the direction of origin does not agree with the instrument's field of view, the ray can be removed as background. By reducing the background to its minimum in this method, 10 times the sensitivity of prior instruments has been achieved.

In the aftermath of the great East Japan earthquake disaster, a wide-angle Compton camera which is the principle technology of the Compton camera on SGD, was brought in within 20 km of the nuclear power plant, and succeeded in the imaging of hotspots. The technology is expected to make future contributions in the visualization of the distribution of radioactive matter and toward applications in medical.

### 2.3.4 Frontier of Satellite Technology

#### Application of "SpaceWire" for satellite communication data

ASTRO-H adopts SpaceWire (ECSS-E-ST-50-12C standard) as the data communication interface that connects the instruments within the satellite. It corresponds to ethernet or USB for ground communication interface, and was created as the international standard for high-speed (1 Mbps or faster) intra-spacecraft communication. ASTRO-H rejected the conventional type low-speed communication interface (such as MIL-1553B standard) and adopted advanced designs that connect the shared satellite systems (data control system, communication system, attitude control system) and almost all observational attitude control system) and almost all observational instruments with SpaceWire. Each instrument connected to the network is controlled by software operated on the satellite computer "SpaceCube2" and TRON-system real time OS "T-Kernel." The satellite was developed with a lower cost and in a shorter time compared to previous satellites, and demonstrates improved reliability.



Figure 2.10: SpaceWire Router with 28 ports to connect multiple instruments

#### Standardization of satellite computer, I/O board for observational instrument

There are 4 different types of X-ray detectors on board ASTRO-H. In order to make the development and testing of all instruments efficient, a standard CPU board and a standard digital I/O board that can be used for control and signal processing of all detectors were developed. The CPU board called "SpaceCard" has the CPU "SOI-SOC2" optimized for SpaceWire interface, and is operated by real time OS "TOPPERS" based on μTRON standards. This structure allows the flexibility to satisfy performance and functional requirements specific to individual detectors. ASTRO-H has 10 CPU boards and 12 digital I/O boards to accommodate the 4 types of detectors, and one of the CPU boards is a backup if a CPU board fails or encounters a problem.

\*1: Technology that reduces the power consumption and increases resistance toward radiation by constructing an integrated circuit over the oxidized silicon layer.

\*2: Technology that integrates the circuit block that controls multiple functions into a single chip.



# 03 ASTRO-H Spacecraft Overview

## 3.1 ASTRO-H Overall Picture

### 3.1.1 Structural Design

In order to point the huge spacecraft to celestial objects with an accuracy of better than 1 arcminute, the ASTRO-H structure consists of the following components:

- two optical benches (FOB, EOB) where the X-ray telescopes and the detectors are mounted,
- Eight side panels where various instruments and electronics are mounted, and
- a base plate and a thrust tube, which combine the above structures, spacecraft, and a rocket

### 3.1.2 Maintaining Long Focal Length

The optical bench employs material with small coefficient of thermal expansion and is designed to be structurally very stable against thermal environmental changes in orbit. Due to the space limitation in the H-IIA nose fairing, the extendable optical bench (EOB) will be extended by 6 m in orbit and maintain a focal length of 12 m for the HXT/HXI.

### 3.1.3 Spacecraft Thermal Design

The spacecraft thermal system has to be designed to maintain operational temperature range for each instrument on board, while minimizing thermal distortion and effectively releasing outside spacecraft the heat (> 2000 W) generated by on board instruments. The heat from the instruments has to be transported directly to the radiator on the side panel without going through the optical bench in order to minimize distortion. A loop heat pipe is used for all the detector systems to effectively transport heat. ASTRO-H uses the loop heat pipe more than previous ISAS spacecraft.

## 3.2 Specifications

Launch timeframe	2015 Japanese FY
Launch site	Tanegashima Space Center
Launch vehicle	H-IIA
Overall length	about 14 m (during observations)
Total weight	2.7 t
Power consumption	3500 W
Lifetime goal	3 years
Orbit	Low earth orbit (altitude about 575 km, inclination 31 deg, orbital period 96 minutes)
Telemetry	8 Mbps (X-band) 2 Mbps (S-band)
Data storage	12 Gbits
Onboard instruments	Soft X-ray Spectrometer (SXS) Soft X-ray Imager (SXI) Hard X-ray Imager (HXI) Soft Gamma-ray Detector (SGD) Soft X-ray Telescope (SXT) Hard X-ray Telescope (HXT)

Figure 3.1: ASTRO-H architecture

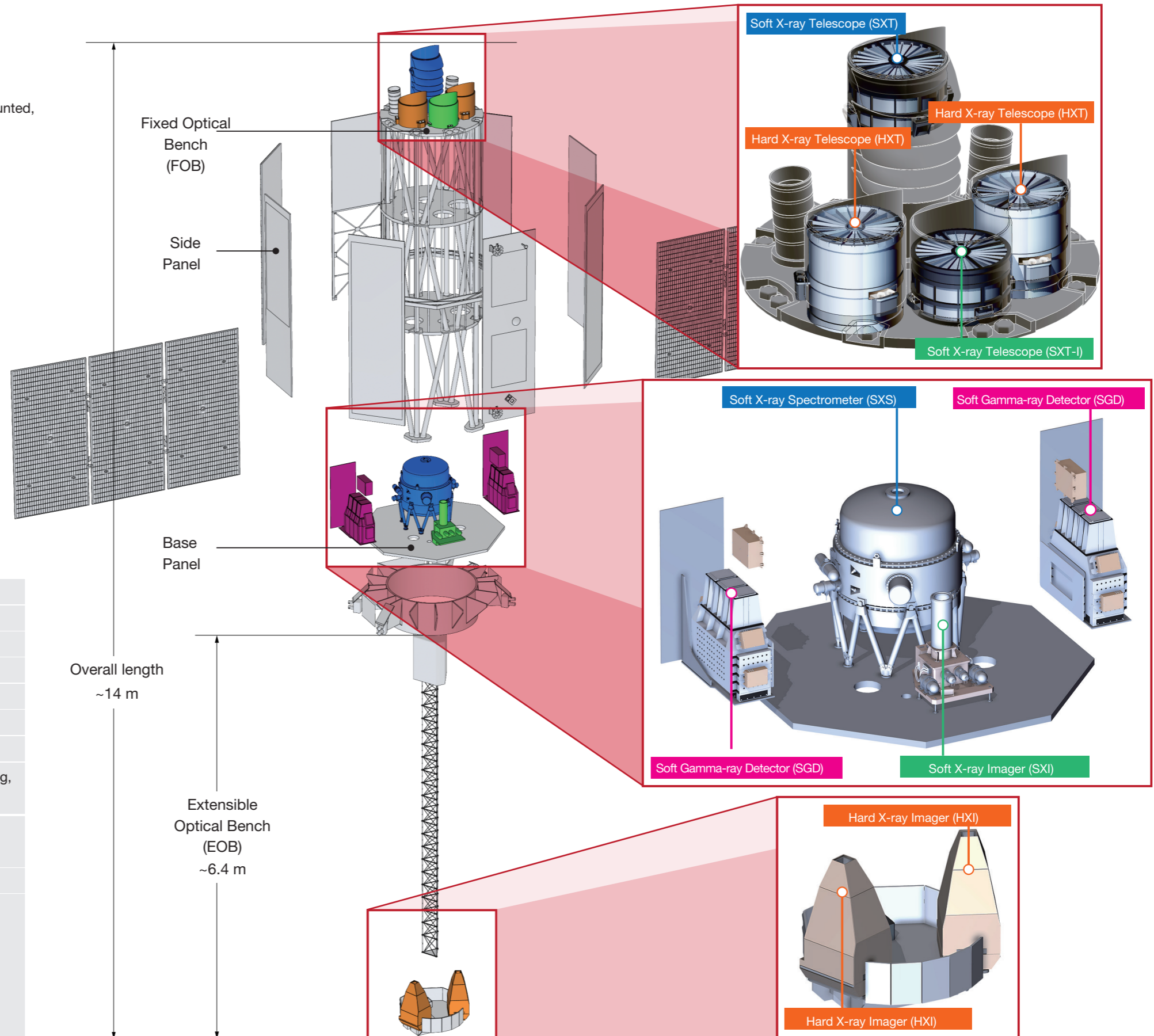
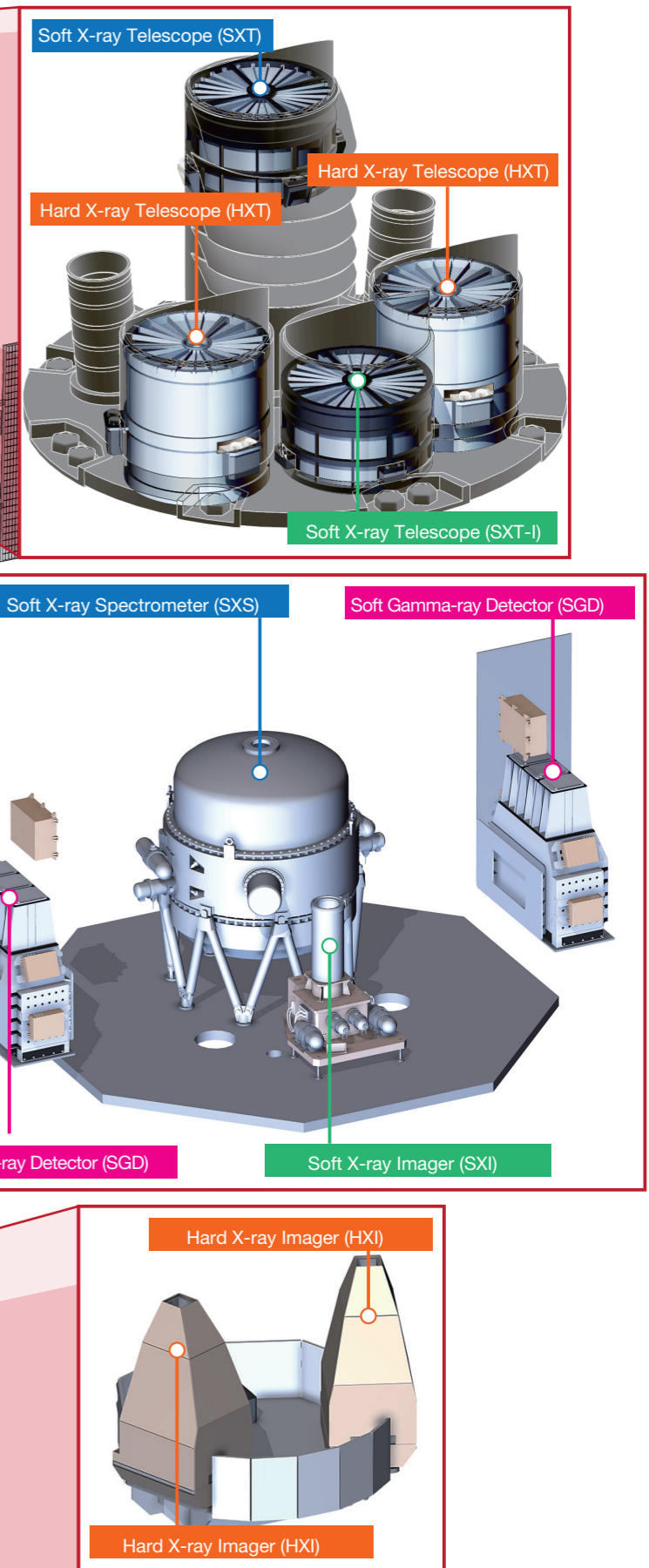

Figure 3.2: ASTRO-H Instruments





**3.3 Science Instrument Specifications**

Combination of X-ray telescopes and focal plane detectors

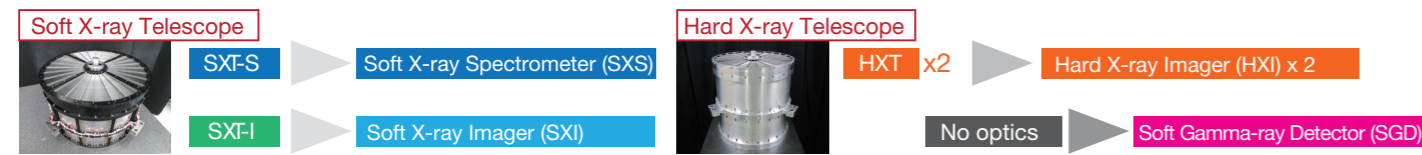

	Soft X-ray Spectrometer (SXS)	Soft X-ray Imager (SXI)	Hard X-ray Imager (HXI)	Soft Gamma-ray Detector (SGD)
Detector type	X-ray microcalorimeter	X-ray CCD	Si/DdTe double sided strip detector	Si/CdTe Compton Camera
Focal length	5.6 m	5.6 m	12 m	-
Collecting area	310 cm <sup>2</sup> @ 6 keV	360 cm <sup>2</sup> @ 6 keV	300 cm <sup>2</sup> @ 30 keV	>20 cm <sup>2</sup> @ 100 keV
Energy band	0.3 ~ 12 keV	0.4 ~ 12 keV	5 ~ 80 keV	60 ~ 600 keV
Energy resolution (FWHM)	<7 eV	<200 eV @ 6 keV	2 keV @ 60 keV	<4 keV @ 60 keV
Angular resolution	<1.3 arcmin	<1.3 arcmin	<1.7 arcmin	-
Field of view	3 arcmin x 3 arcmin	38 arcmin x 38 arcmin	9 arcmin x 9 arcmin	0.6 deg x 0.6 deg

Table 3.1 Detector Specifications

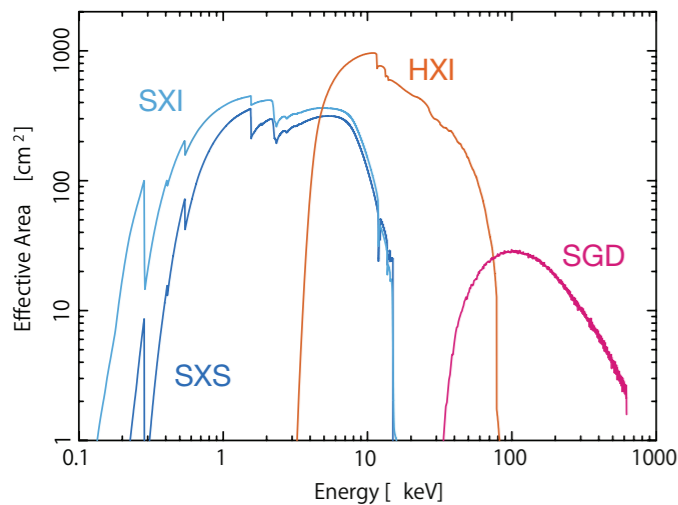

Figure 3.3: Effective area of ASTRO-H science instruments. The HXI and SGD plots are for two units.

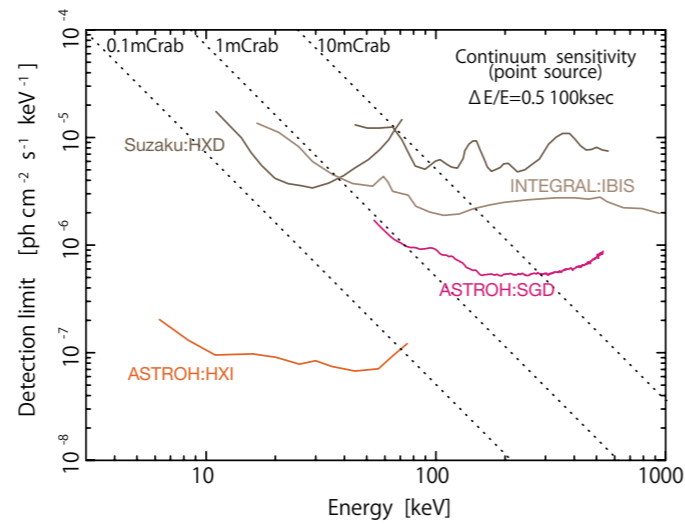

Figure 3.4: Energy band and limiting sensitivity of ASTRO-H hard X-ray/soft Gamma-ray instruments. Suzaku and INTEGRAL (ESA) are also shown for comparison. HXI and SGD have 100 and 10 times greater sensitivity over Suzaku, respectively.

**3.4 Development Schedule**

ASTRO-H launch is planned for the 2015 Japanese fiscal year, on a JAXA H-IIA launch vehicle from Tanegashima Space Center in Japan, 12 years after the original proposal, and 7 years after the project started. Since ASTRO-H spacecraft is too big for construction at ISAS, it is integrated at Tsukuba Space Center and has been tested in various environments.

Year	Month
2003	November
2004	September
2008	October

1st proposal  
2nd proposal  
ASTRO-H project officially started

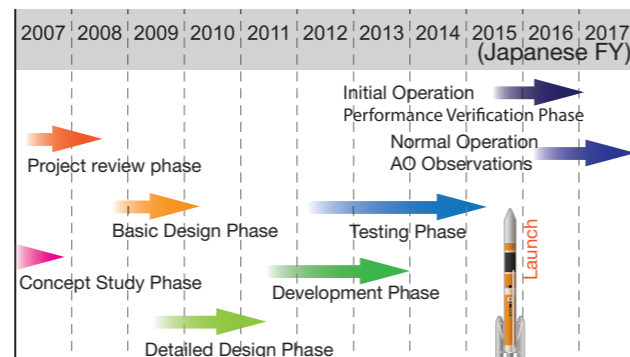

Figure 3.5: ASTRO-H mission schedule (Japanese fiscal year)

**3.5 ASTRO-H Launch and Flight Sequence**

After the separation of the spacecraft from the rocket, the most critical operations will be performed first, such as acquiring direction to the Sun and deployment of the solar panel, in order to ensure a safe condition for the spacecraft. Next, the spacecraft will start attitude control, functional test of bus components, initial start-up of science instruments, the EOB extension, and so on.

The first 3 months (Phase 0) are dedicated to the initial start up and the functional tests (1.5 months) and calibration observations (1.5 months).

Operations after Phase 0 are described in Section 3.9.2.

Time	Major events after the launch
4 min	Nose fairing separation (A)
6 min	First stage and second stage separation (B)
14 min	ASTRO-H separation (C)

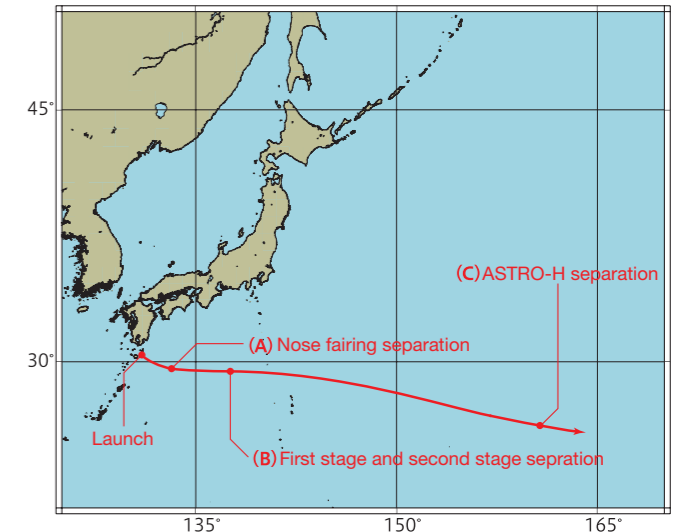

Figure 3.6: Rocket trajectory until the ASTRO-H separation with major events.

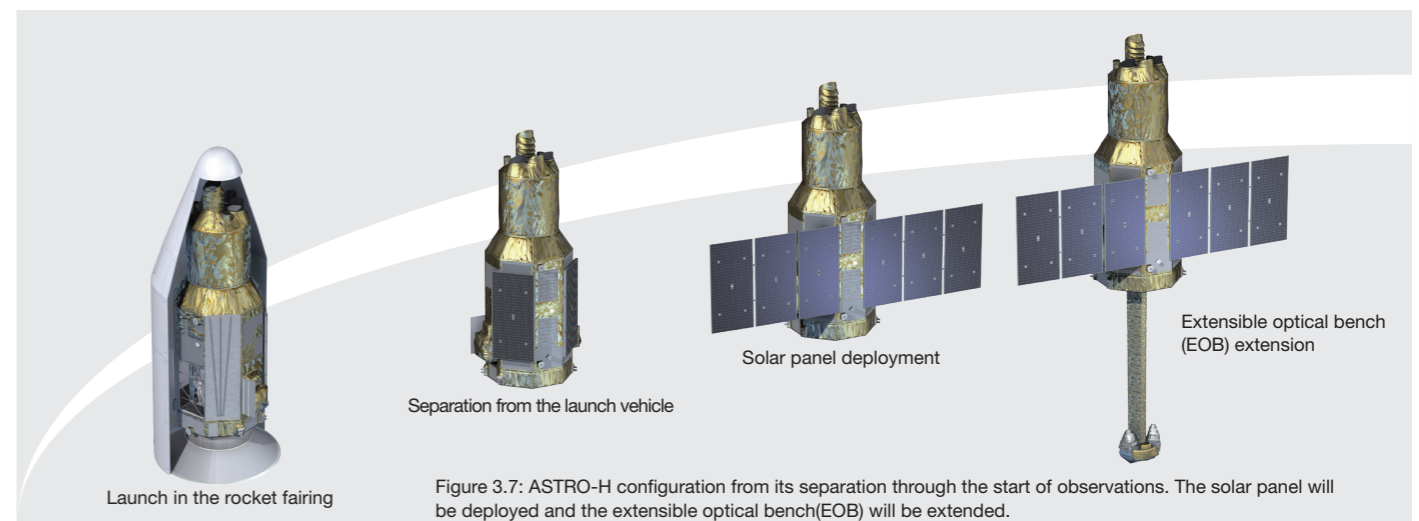

Figure 3.7: ASTRO-H configuration from its separation through the start of observations. The solar panel will be deployed and the extensible optical bench (EOB) will be extended.

**3.6 ASTRO-H Orbit**

ASTRO-H will orbit around the earth at an altitude of 575 km with an inclination angle of 31 deg. While it completes one revolution every 96 min, the spacecraft will maintain its attitude towards a celestial object and observe it continuously, typically for a couple of days.

During normal observing mode, ASTRO-H controls its attitude with an accuracy of 17 arcsec. The attitude is determined by two star trackers onboard ASTRO-H, which give feedback to the attitude control system with reaction wheels. They maneuver or maintain the ASTRO-H attitude. Once one observation is completed, ASTRO-H maneuvers to the next target based on a pre-determined observation plan.

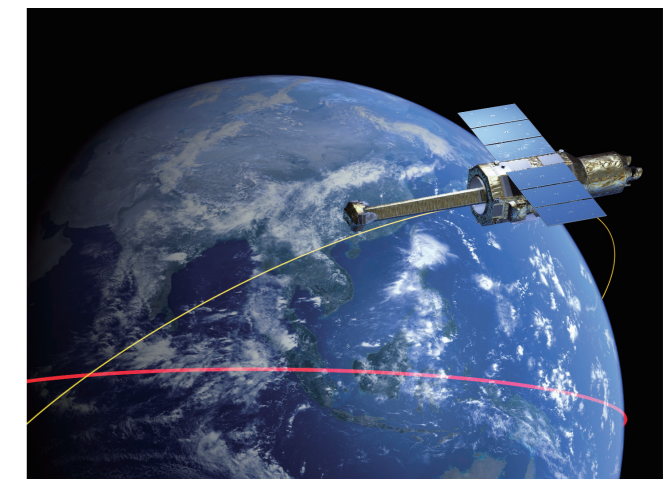

Figure 3.8: ASTRO-H orbit



### 3.7 System Block Diagram

All the components in the spacecraft bus and the science instruments communicate through the SpaceWire network. ASTRO-H bus system has a full redundant configuration for the first time as an ISAS science satellite.

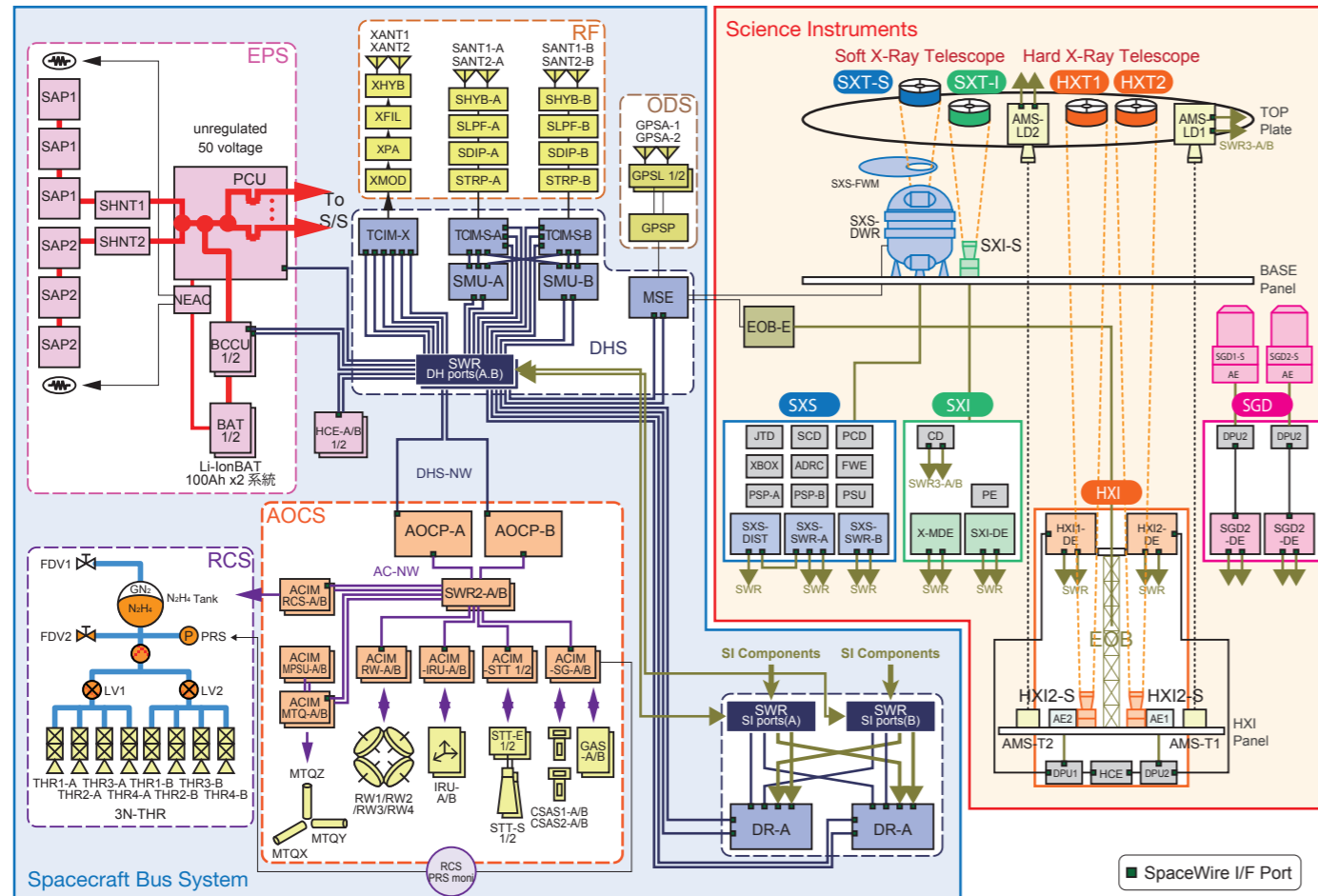

Figure 3.9: System block diagram. A is the primary and B is the redundant system.

#### 3.7.1 Spacecraft Bus System

<b>DHS</b>	<b>データ処理系</b> Data Handling System
SMU	衛星マネージメントユニット Satellite Management Unit
DR	データレコーダー Data Recorder
SWR	28-port SpaceWireルーター 28-port SpaceWire Router
TCIM-S	テレメトリコマンドインタフェースモジュールS Telemetry Command Interface Module-S
TCIM-X	テレメトリコマンドインタフェースモジュールX Telemetry Command Interface Module-X
MSE	ミッションサポート装置 Mission Support Equipment
<b>RF</b>	<b>通信系</b> Communication System
SANT	Sバンドアンテナ S-band Antenna
SHYB	Sバンドハイブリッド S-band Hybrid
SDIP	Sバンドダイプレクサ S-band Diplexer
STRP	Sバンドトランスポンダ S-band Transponder
SLPF	Sバンドフィルタ S-band Filter

XANT	Xバンドアンテナ X-band Antenna
XHYB	Xバンドハイブリッド X-band Hybrid
XFIL	Xバンドフィルタ X-band Filter
XMOD	Xバンド変調器 X-band Modulator
XPA	Xバンドパワーアンプ X-band Power Amplifier

#### EPS 電源系 Power Supply System

SAP	太陽電池パドル Solar Array Paddle
PCU	電力制御器 Power Control Unit
SHNT	シャント装置 Shunt Dissipater
BCCU	バッテリー充電制御器 Battery Charge Control Unit
BAT	バッテリー Battery
NEAC	NEA制御器 NEA Controller

#### TCS 熱制御系 Thermal Control System

HCE	ヒータ制御装置 Heater Control Electronics
-----	---------------------------------------

<b>AOCS</b>	<b>姿勢起動制御系</b> Attitude and Orbit Control System
AACP	姿勢起動制御計算機 Attitude and Orbit Control Processor
ACIM-RW	姿勢インターフェイスモジュールRW AC Interface Module RW
ACIM-IRU	姿勢インターフェイスモジュールIRU AC Interface Module IRU
ACIM-STT	姿勢インターフェイスモジュールSTT AC Interface Module STT
ACIM-SG	姿勢インターフェイスモジュールSG AC Interface Module SG
ACIM-MTQ	姿勢インターフェイスモジュールMTQ AC Interface Module MTQ
ACIM-MPSU	姿勢インターフェイスモジュールMPSU AC Interface Module MPSU
ACIM-RCS	姿勢インターフェイスモジュールRCS AC Interface Module RCS
RW	リアクションホイール Reaction Wheel
MTQ	磁気トルク Magnetic Torquer
STT-S	恒星センサー Star Tracker Sensor
STT-E	恒星センサー制御装置 Star Tracker Electronics
IRU	慣性基準装置 Inertial Reference Unit

#### 3.7.2 Science Instruments

<b>OB</b>	<b>光学ベンチ</b> Optical Bench
EOB	伸展式光学ベンチ Extensible Optical Bench
FOB	固定式光学ベンチ Fixed Optical Bench
EOB-E	伸展式光学ベンチ制御装置 Extensible Optical Bench Electronics
<b>XRT</b>	<b>X線ミラー系</b> X-ray Telescope
HXT	硬X線望遠鏡 Hard X-ray Telescope
SXT-S	軟X線望遠鏡 Soft X-ray telescope (SXS)
SXT-I	軟X線望遠鏡 Soft X-ray telescope (SXI)
<b>SXS</b>	<b>軟X線分光検出器</b> Soft X-ray Spectrometer
SXS-DWR	SXS デューワー (真空断熱容器) SXS Dewar
SXS-SCD	SXSシールド冷凍機駆動装置 SXS Shield Cooler Driver
SXS-PCD	SXS前段冷凍機駆動装置 SXS Pre Cooler Driver
SXS-JTD	SXSジュールトムソン冷凍機駆動装置 SXS Joule-Thomson Cooler Driver
SXS-ADRC	SXS断熱消磁冷凍機制御装置 SXS ADR Controller
SXS-XBOX	SXS アナログ波形処理装置 SXS X-ray BOX
SXS-PSP	SXS デジタル波形処理装置 SXS Pulse Shape Processor
SXS-FWM	SXSフィルターホイール SXS Filter Wheel Mechanics
SXS-FWE	SXSフィルターホイール制御装置 SXS Filter Wheel Electronics
SXS-PSU	SXS 電源装置 SXS Power Supply Unit

CSAS	粗太陽センサー Coarse Sun Aspect Sensor
GAS	磁気センサー Geomagnetic Aspect Sensor
SWR	14-port SpaceWireルーター 14-port SpaceWire Router
<b>RCS</b>	<b>推進系</b> Reaction Control System
3N-THR	3Nスラスタ 3N Thruster
VLVM	バルブモジュール Valve Module
TNK	燃料タンク Propellant Tank
<b>AMS</b>	<b>アライメント計測系</b> Alignment Measurement System
AMS-LD	光源検出器 Laser and Detector
AMS-T	ターゲットマーカー Target Marker
<b>ODS</b>	<b>軌道決定系</b> Orbit Determination System
GPSA	GPSアンテナ GPS Antenna
GPSP	GPS受信機 GPS Processor
GPSL	GPS LNA GPS LNA

SXS-SWR	SXS SpaceWireルーター SXS SpaceWire Router
SXS-DIST	SXS電力分配器 SXS Distributer
<b>SXI</b>	<b>軟X線撮像検出器</b> Soft X-ray Imager
SXI-S	SXI センサー SXI Sensor
SXI-CD	SXI冷凍機駆動装置 SXI Cooler Driver
SXI-PE	SXIピクセル処理装置 SXI Pixel Processing Electronics
SXI-DE	SXIデジタル装置 SXI Digital Electronics
X-MDE	エクストラミッションデジタル装置 eXtra - Mission Digital Electronics
<b>HXI</b>	<b>硬X線撮像検出器</b> Hard X-ray Imager
HXI-S	HXI センサー HXI Sensor
HXI-DPU	HXI データ処理装置 HXI Data Processing Unit
HXI-DE	HXIデジタル装置 HXI Digital Electronics
HXI-AE	HXIアナログ装置 HXI Analog Electronics
HXI-HCE	HXI熱制御装置 HXI Heater Control Electronics
<b>SGD</b>	<b>軟ガンマ線検出器</b> Soft Gamma-Ray Detector
SGD-S	SGD センサー SGD Sensor
SGD-DPU	SGDデータ処理装置 SGD Data Processing Unit
SGD-DE	SGDデジタル装置 SGD Digital Electronics
SGD-AE	SGDアナログ装置 SGD Analog Electronics



# 03 ASTRO-H Spacecraft Overview

## 3.8 Ground Station and Operation System

The 34 m and 20 m antennas at Uchinoura Space Center (USC) in Kagoshima, Japan as well as Katsuura ground station (KTU Station #4, KTU4) will be used for ground communication with ASTRO-H in-orbit. Two bands, S-band (2GHz band) and X-band (8GHz band), are used for telemetry/commanding transmission. The S-band is used for commanding and housekeeping transmission such as battery level, temperature, attitude, because the S-band is more stable. On the other hand, as the X-band is 4 times faster than S-band, it is used to transmit large amount of science data to the ground. Also, Masuda ground station (MSD1) will be used to track the spacecraft during the launch. For the normal operation, Santiago ground station (SNT1), Maspalomas ground station (MSP1), and Mingenew ground station (MGN1) will be used to support communication with ASTRO-H (only for S-band).

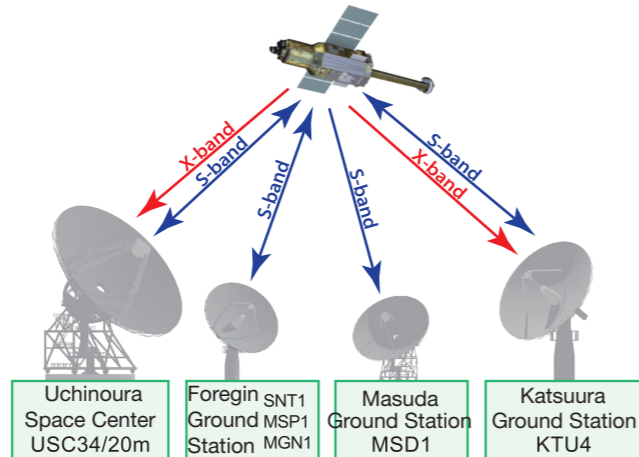

Figure 3.10: Ground stations used for ASTRO-H and telemetry band to be used. Arrow indicates transmission direction.

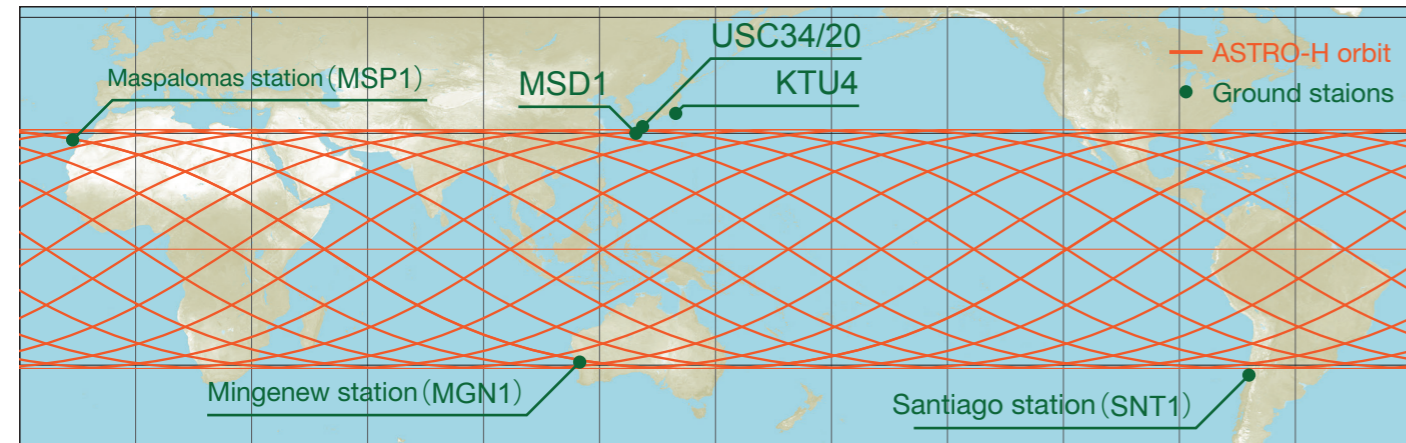

Figure 3.11: Location of the ASTRO-H ground stations with ASTRO-H orbits. ASTRO-H orbits around the earth every 96 mins. The spacecraft receives sunlight for 2/3 of a day and it is in shade for 1/3 of the day, while it goes around 15 times a day. ASTRO-H will be visible from Japan 5 times out of the 15. It will be in communication for about 10 min during each pass. During that time, commands will be sent and data will be downloaded to the ground.

## 3.9 Open Observatory ASTRO-H

### 3.9.1 International proposal calls for observations

ASTRO-H observing time will be available for any scientist across the world, based upon proposal selection (Guest Observation), following the initial operation and the calibration observation (Phase 0) and the ASTRO-H Science Working Group observing time (Phase 1). Submitted proposals will be selected by a peer review and the selected proposals will be awarded observing time. All the data will be subjected to a proprietary period, and will thereafter be made available publicly along with analysis software. ASTRO-H data will be a worldwide asset that anyone can access.

### 3.9.2 Schedule through Guest Observation

Phase 0	3 months	Initial operation and calibration (100%)
Phase 1	6 months	Performance Verification (100%)
Phase 2	12 months	Performance Verification (25%) Guest Observations (75%)
Phase 3	Rest	Performance Verification (10%) Guest Observations (90%)

### 3.9.3 Analysis software

The hardware team and the software team have been working together to understand characteristics of the science instruments and build the calibration database. In order to obtain enough calibration accuracy to archive the ASTRO-H science goals, the team has developed an algorithm to best utilize the database. In order to make the ASTRO-H data widely available to the community, the data format adopted is the the world standard defined by NASA for easy access. In addition, the easy-to-use ASTRO-H software package will be made available for free, which will allow anyone to analyze the data.

### 3.9.4 International open observatory

ASTRO-H is open to scientists in any field outside the team. The project will be not only soliciting observation proposals, but also providing an analysis guide and a technical description document. Those documents will be updated regularly. A help-desk will also be open in several locations around the world. ASTRO-H users can ask questions about any aspect of the data analysis.

## 3.10 International Collaboration

ASTRO-H is being developed in collaboration among more than 250 scientists from many institutions and universities over the world, and researchers, engineers, graduate students and industries are working together on the development.

### 61 Institutions and universities in the ASTRO-H collaboration



宇宙航空研究開発機構 Japan Aerospace Exploration Agency	National Aeronautics and Space Administration アメリカ航空宇宙局	European Space Agency 欧州宇宙機関
Netherlands Institute for Space Research (SRON) オランダ宇宙研究機関	Canadian Space Agency カナダ宇宙庁	
愛知教育大学 Aichi University of Education	愛媛大学 Ehime University	大阪大学 Osaka University
金沢大学 Kanazawa University	関西学院大学 Kwansei Gakuin University	九州大学 Kyusyu University
埼玉大学 Saitama University	静岡大学 Shizuoka University	芝浦工業大学 Shibaura Institute of Technology
筑波大学 University of Tsukuba	東京大学 University of Tokyo	東京工業大学 Tokyo Institute of Technology
名古屋大学 Nagoya University	奈良教育大学 Nara University of Education	奈良女子大学 Nara Women's University
山形大学 Yamagata University	理化学研究所 RIKEN	立教大学 Rikkyo University
CEA/DSM/IRFU フランス宇宙基礎科学研究所	Harvard-Smithsonian Center for Astrophysics ハーバード・スミソニアン天体物理学センター	Columbia University コロロンビア大学
Durham University ダラム大学	Jagiellonian University ヤギェウォ大学	Johns Hopkins University ジョンズ・ホプキンス大学
Massachusetts Institute of Technology マサチューセッツ工科大学	Rutgers University ラトガース大学	Saint Mary's University セントメアリーズ大学
Space Telescope Science Institute 宇宙望遠鏡科学研究所	University of Cambridge ケンブリッジ大学	University of Geneva ジュネーブ大学
University of Miami マイアミ大学	University of Michigan ミシガン大学	University of Southampton サウサンプトン大学
		University of Waterloo ウォーターロー大学
		University of Wisconsin ウイスコンシン大学
		Yale University イェール大学
		沖繩科学技術大学院大学 Okinawa Institute of Science and Technology
		高知工科大学 Kochi University of Technology
		神戸大学 Kobe University
		中部大学 Chubu University
		東北学院大学 Tohoku Gakuin University
		宮崎大学 University of Miyazaki
		ダブリン高等研究所 Dublin Institute for Advanced Studies
		ローレンス・リバモア国立研究所 Lawrence Livermore National Laboratory
		スタンフォード大学 Stanford University
		マニトバ大学 University of Manitoba
		メリーランド大学 University of Maryland