



Annual QPB Progress

K.D.Kuntz (JHU)

Unresolved MOS Issues

- Anomalous states
 - Cause? (Beyond our analysis!)
 - Detection criteria
 - The question of intermediate states**Discussed 3/18**
- QPB line/continuum ratio variation (Thanks you, Pierre Maggi) **Hiatus**
- Temporal variation in the QPB continuum shape
 - Source?
 - Amplitude?
 - And does it matter?**TBD 3/19**
- Spatial variation of the QPB spectral shape
 - Amplitude?
 - And does it matter?**Real Soon Now**

Unresolved pn Issues

- Why do the corner data after OOT correction still contain structure from the FOV?
- Why do the SPF scatter into the corner data for the pn and not the MOS?
- Temporal variation in the QPB continuum shape **Hiatus**

Unresolved ESAS Implementation Issues

MOS Previous Attempt

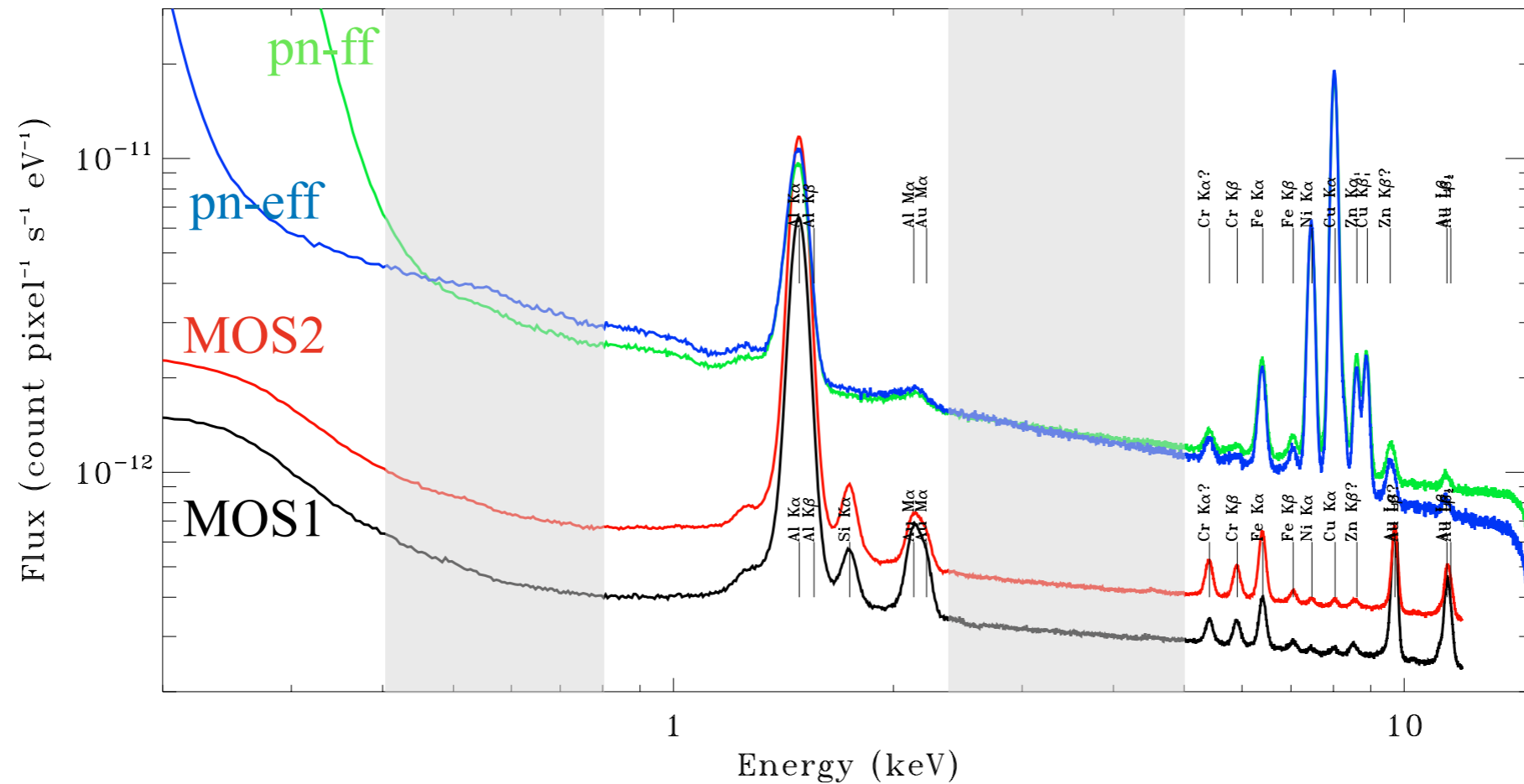

The spectral shape known to be temporally variable (not shown here)

For corner data from a single chip, create a mean spectrum.

Simulate the entire archive using mean spectrum & Poisson stats

If $HR \equiv (2.5-5.0 \text{ keV}) / (0.4-0.8 \text{ keV})$

Then the simulated distribution of HR does not match the measured distribution of HR.

My main interest is continuum shape since the line strengths vary strongly.

MOS Previous Attempt

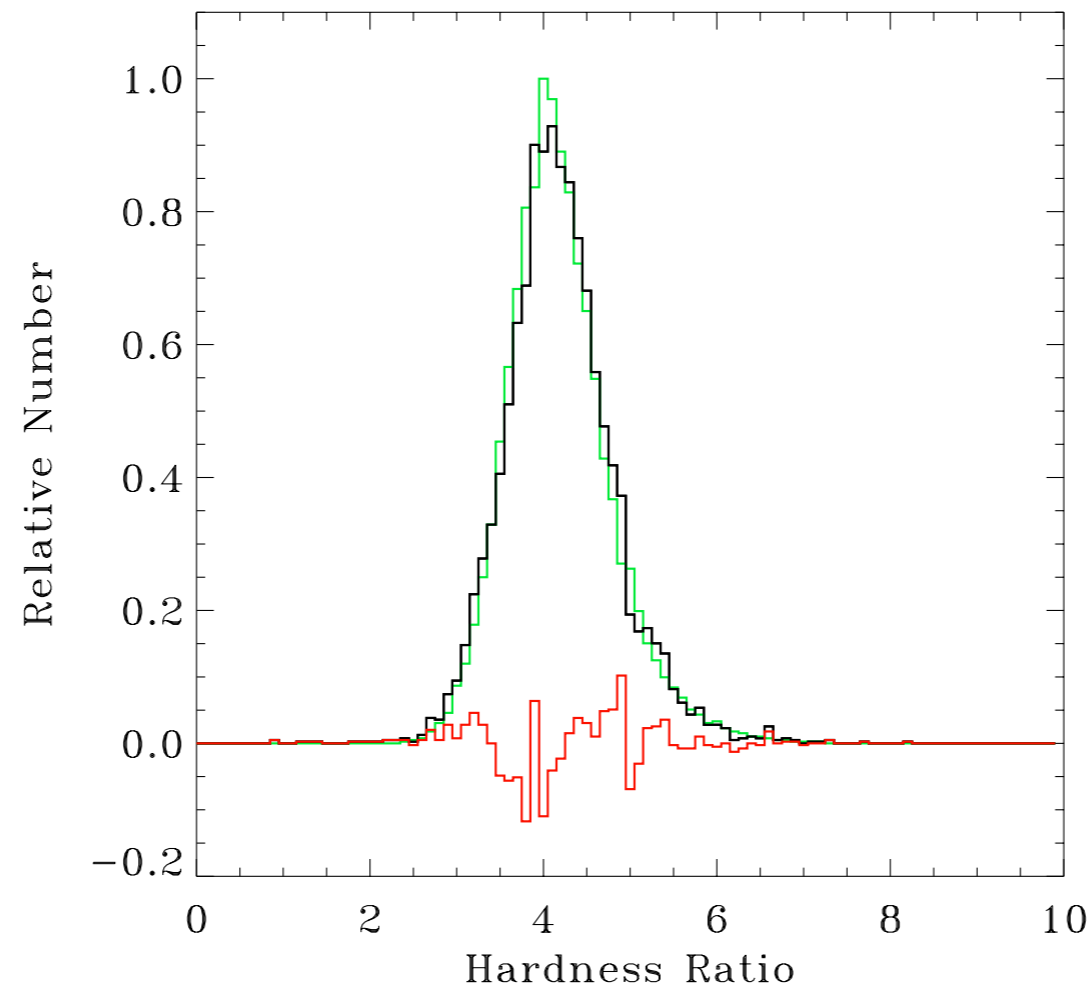

The spectral shape known to be temporally variable (not shown here)

For corner data from a single chip, create a mean spectrum.

Simulate the entire archive using mean spectrum & Poisson stats

If $HR \equiv (2.5-5.0 \text{ keV}) / (0.4-0.8 \text{ keV})$

Then the simulated distribution of HR does not match the measured distribution of HR.

The distributions are close, but KS tests suggest $<1\%$ prob. of same.

MOS Previous Attempt

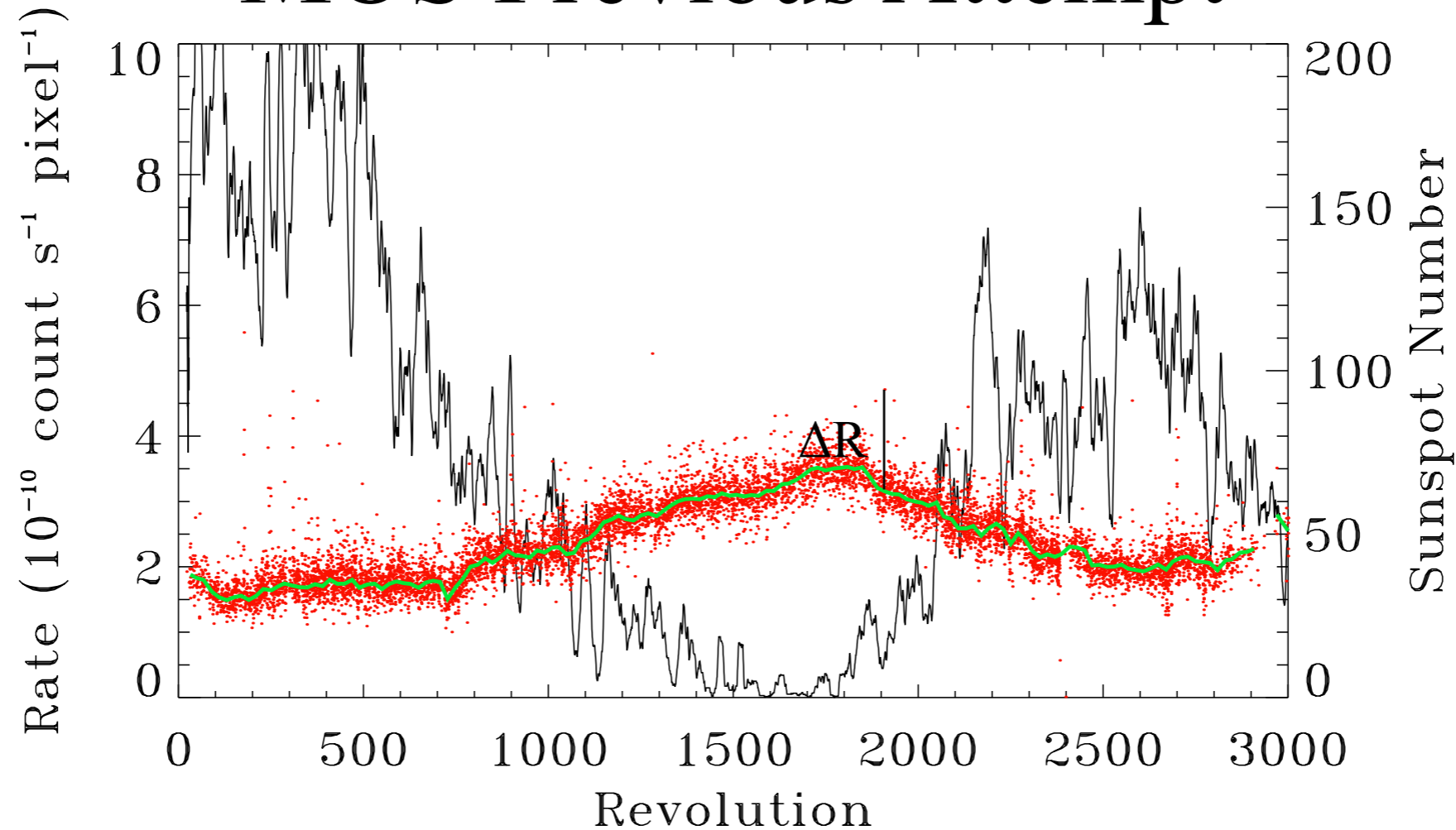

What is the source of the temporal variation? Some choices:

- Epoch (perhaps due to instrument evolution)
- QPB Rate (varies with the solar cycle)
- ΔR - difference between rate and mean rate at an epoch
(source of variation unclear)

The QPB rate calc'd from MOS2-3, 2-4, 2-6 & 2-7 for the best statistics.
However, the spectrum as functions of E, R, ΔR uninformative.

New Approach

The Goddard group looked at soft proton flares as a function of location.
An ISSI workshop last April explored QPB as a function of location.
In preparation, looked at Rate and ΔR as a function of location.

Expected Rate to increase as XMM approaches perigee
and enters the particle belts

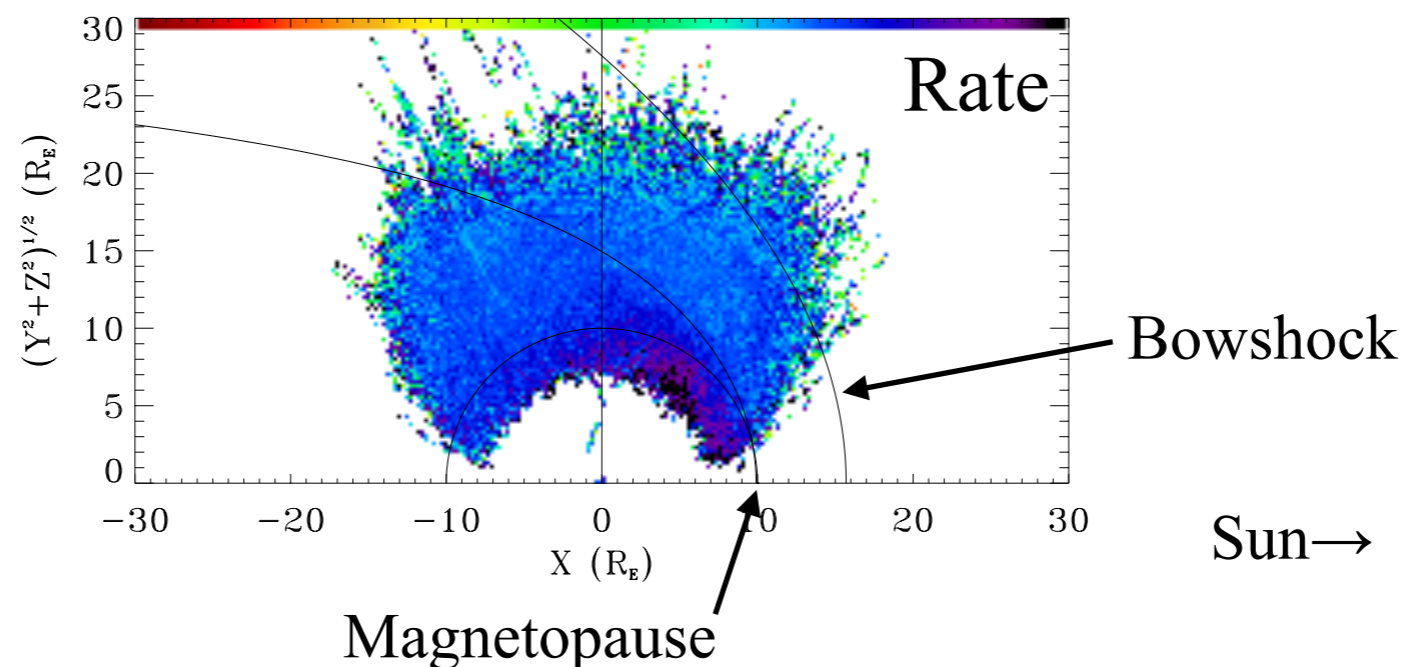

Rotationally Summed
Around Earth-Sun Line

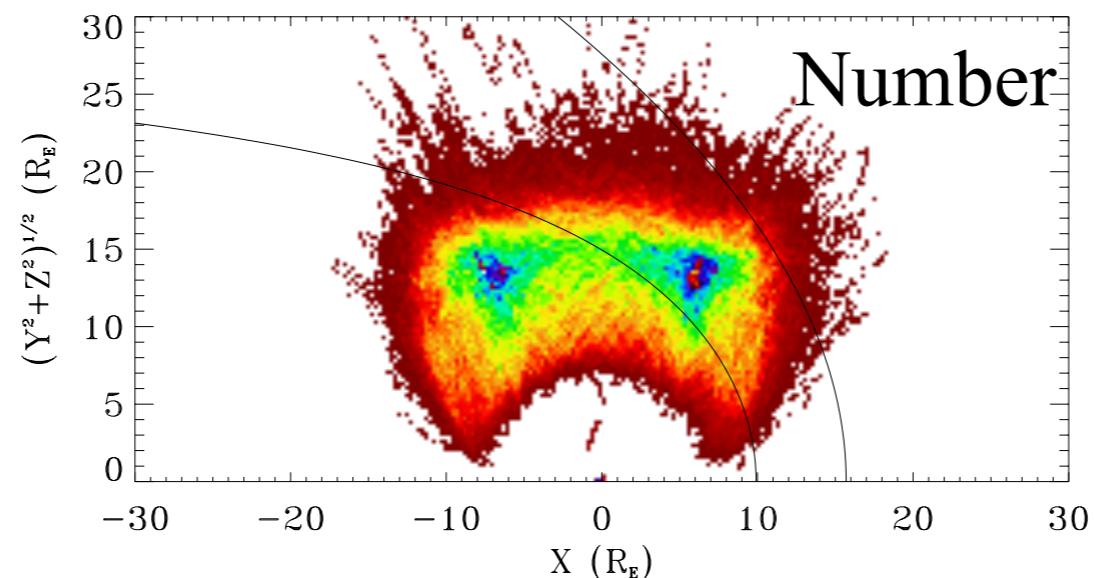

New Approach

We find that ΔR is a strong function of the spacecraft location:

Strong inside magnetopause,
uniform elsewhere!

The ΔR strongly correlated with LE1
(low energy channel of the Rad.Mon.)

The ΔR not correlated with LE2
(higher energy channel)

These plots created from corner data for non-anomalous MOS2 chips binned into one minute intervals.

Since the MP & BS move due to changes in the solar wind pressure, the location of the spacecraft wrt the MP & BS calculated every minute.

Not computationally cheap!

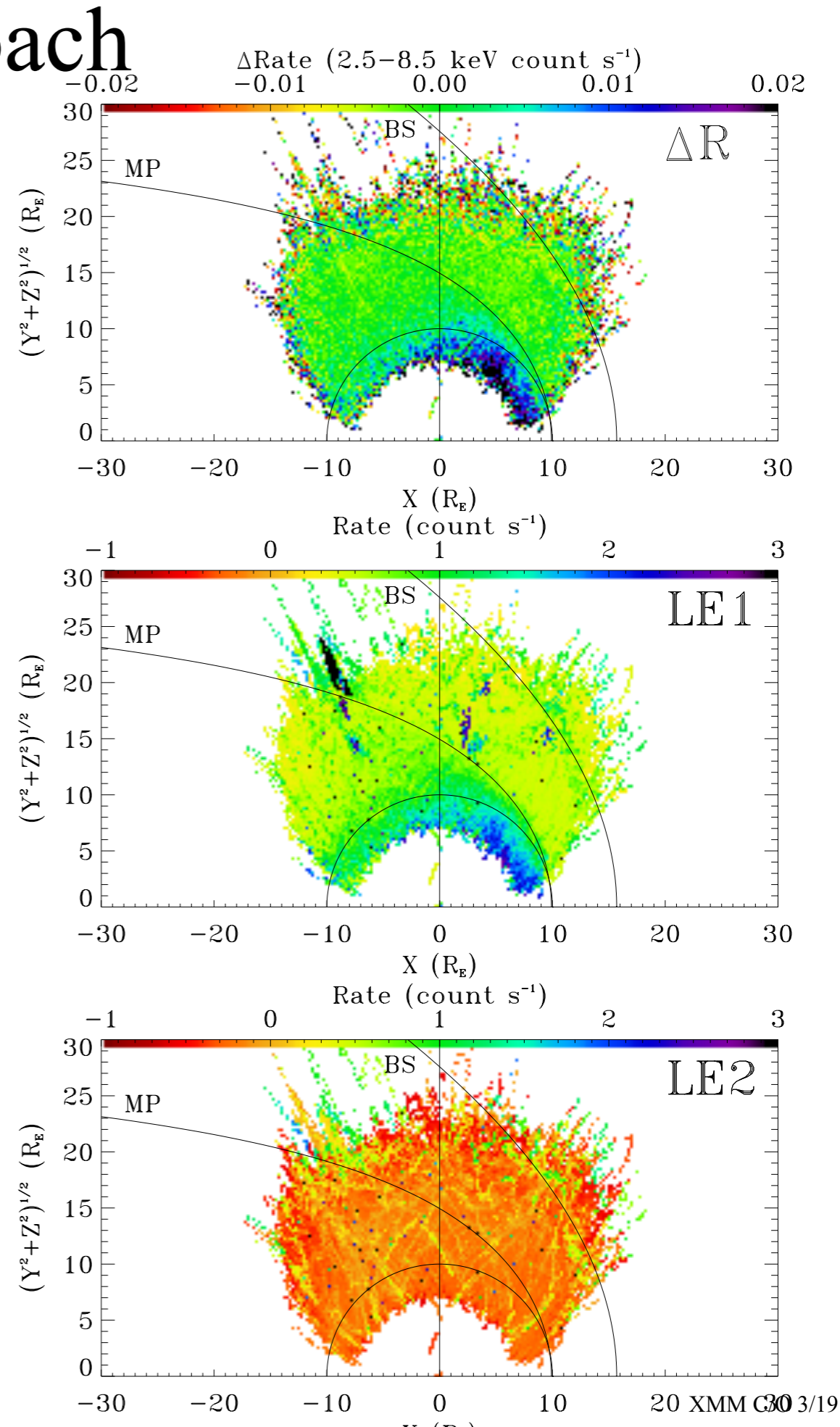

New Approach

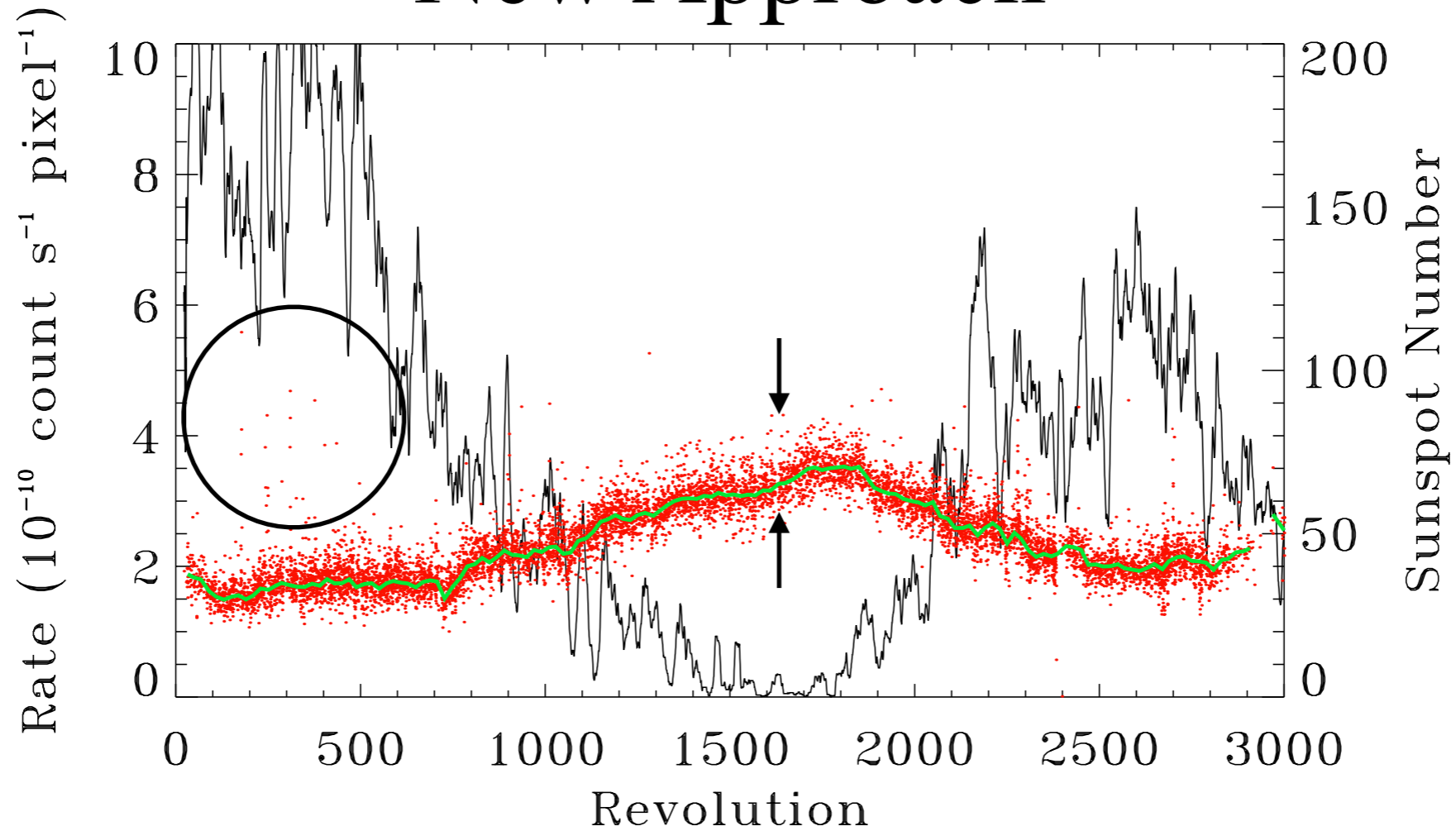

ΔR is in part statistical, but also depends upon location

ΔR is under-represented in this plot - done on obsid-by-obsid basis

And any given obsid may contain emission from multiple regions

Previous ΔR analysis failed to show strong results -

That ΔR done on an obsid basis - dominated by statistics

New Approach

For each observation (obsid)

- extracted corner spectra as a function of the spacecraft location

As spacecraft approaches perigee

- continuum shape changes
- line/continuum rate decreases

Bulk of the spacecraft time spent in region with a relatively constant spectral shape.

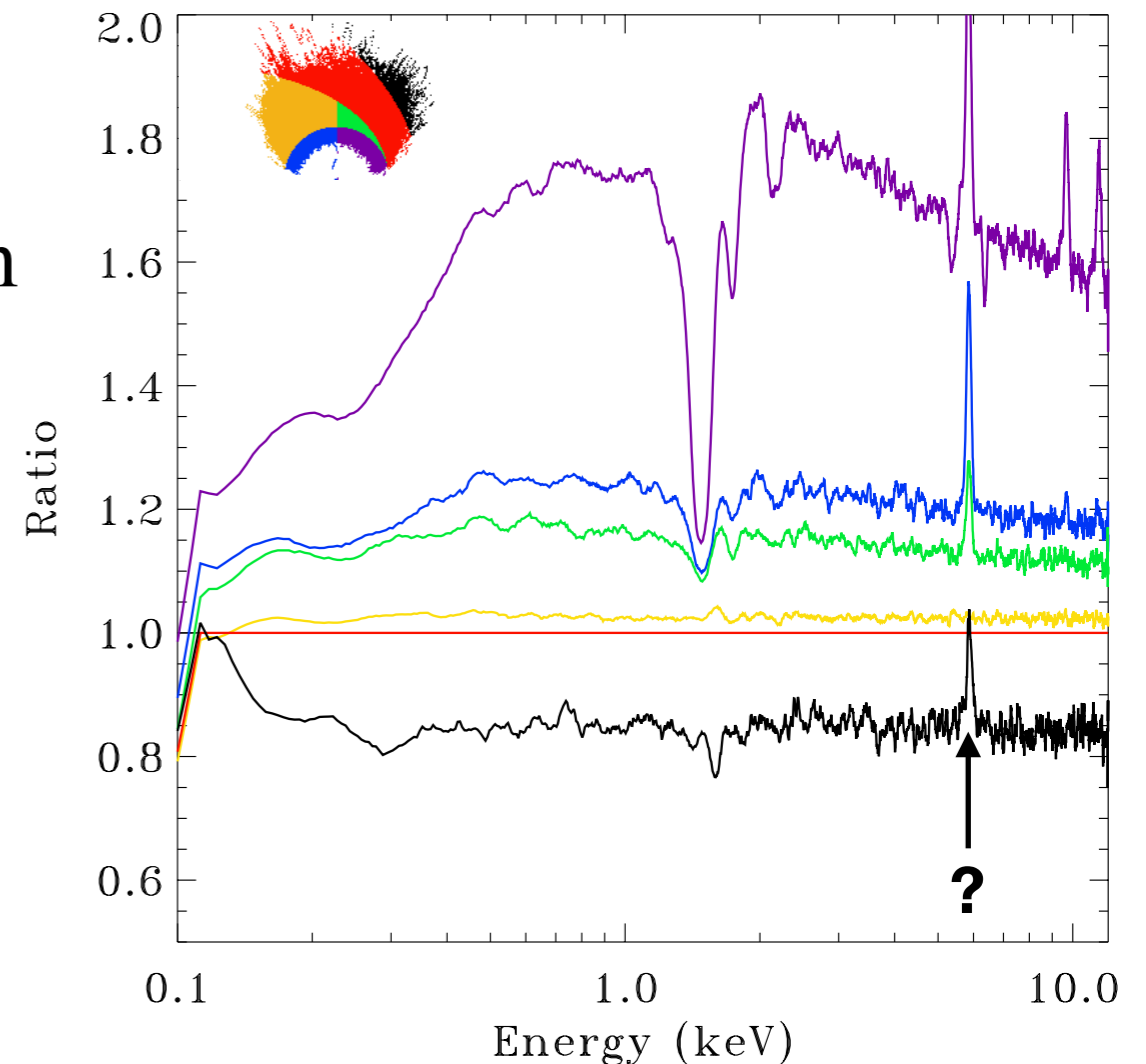
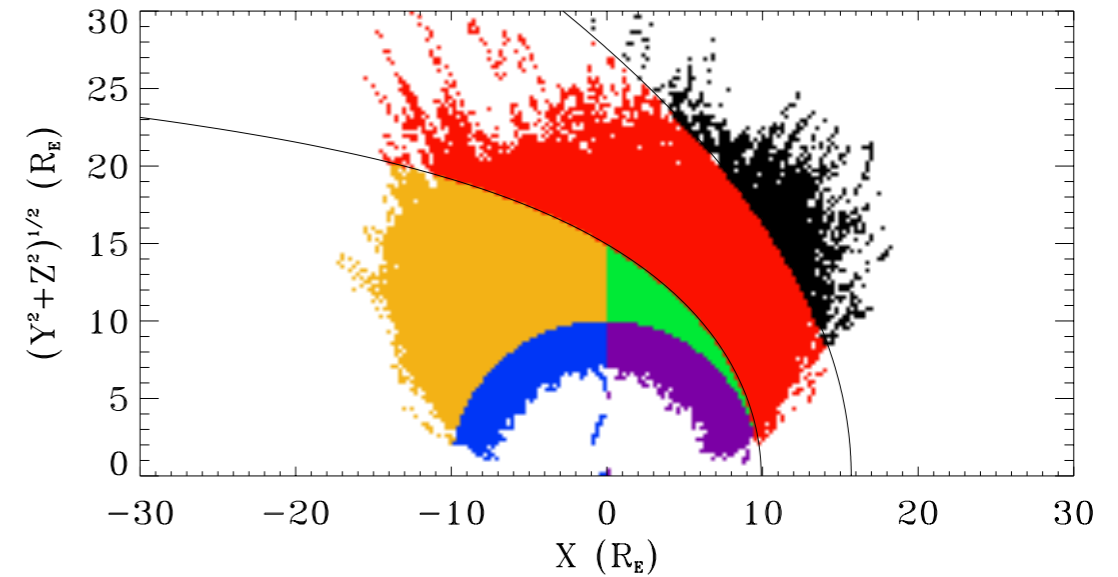

New Approach

However, location isn't everything....

- distribution of ΔR for each region shows low ΔR possible even near perigee just not as common

So look at spectrum from peak of ΔR distribution for each region:

- spectra are remarkably similar

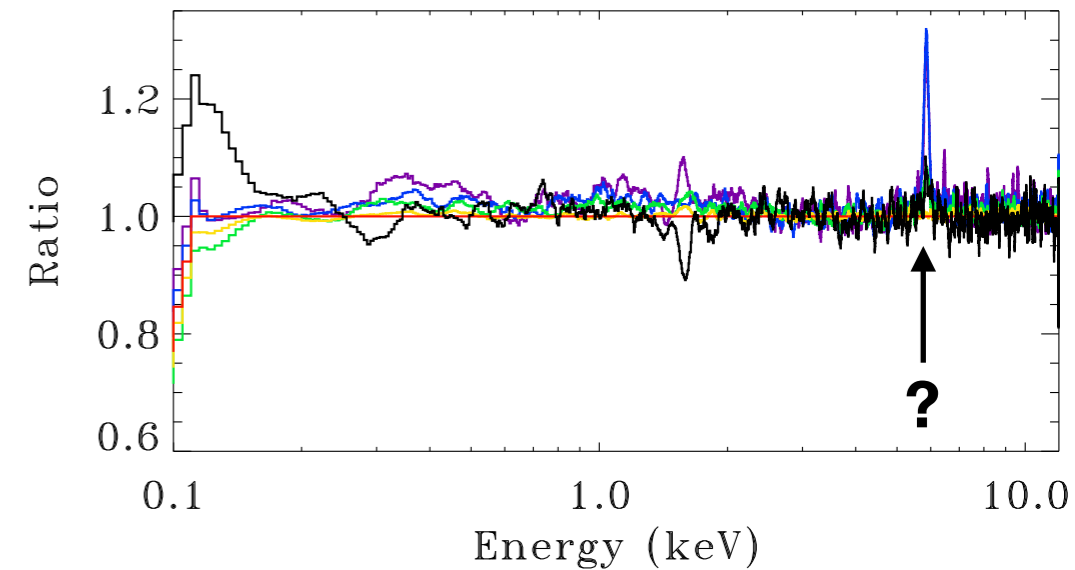
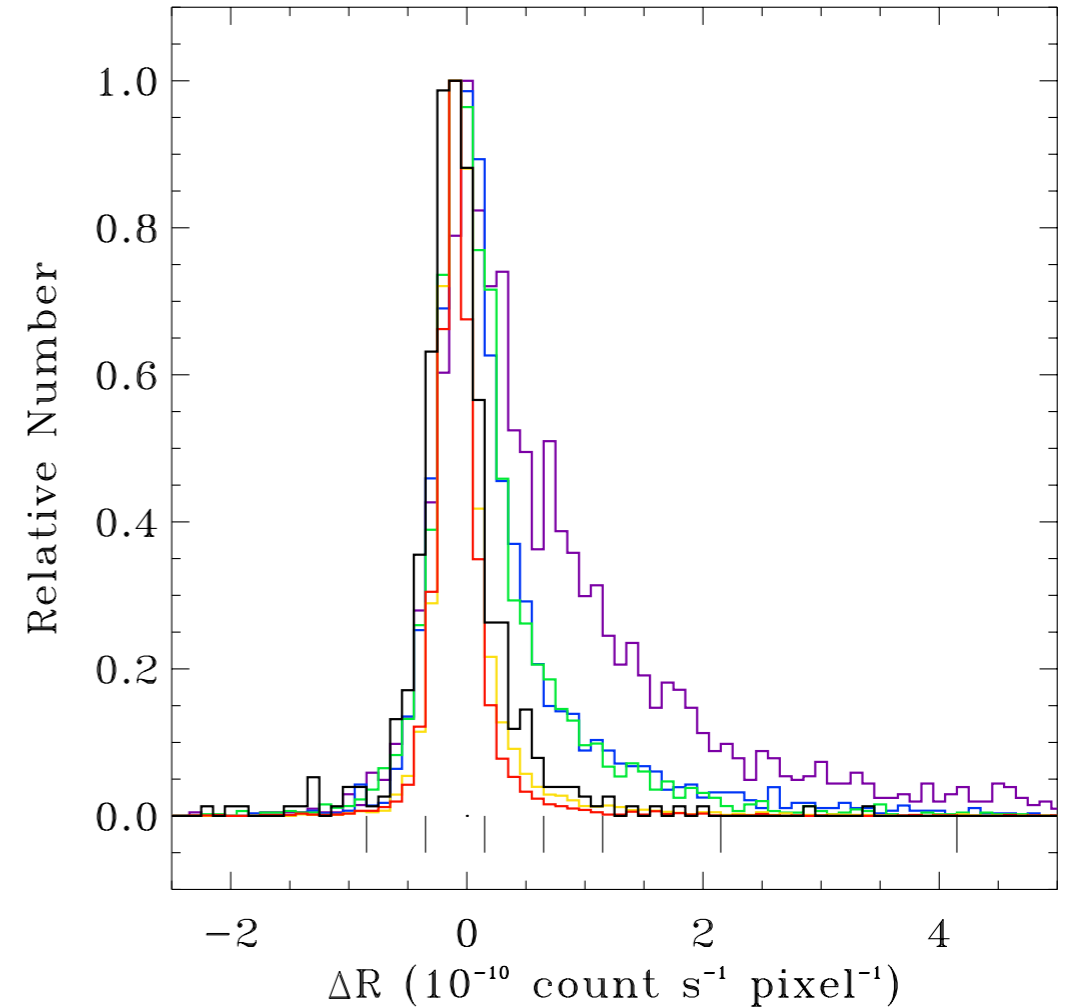

New Approach

Ratio of spectra with different ΔR , from lowest ΔR (purple) to high ΔR (red).

Thus, ΔR is correlated with a strong variation in the spectral shape.

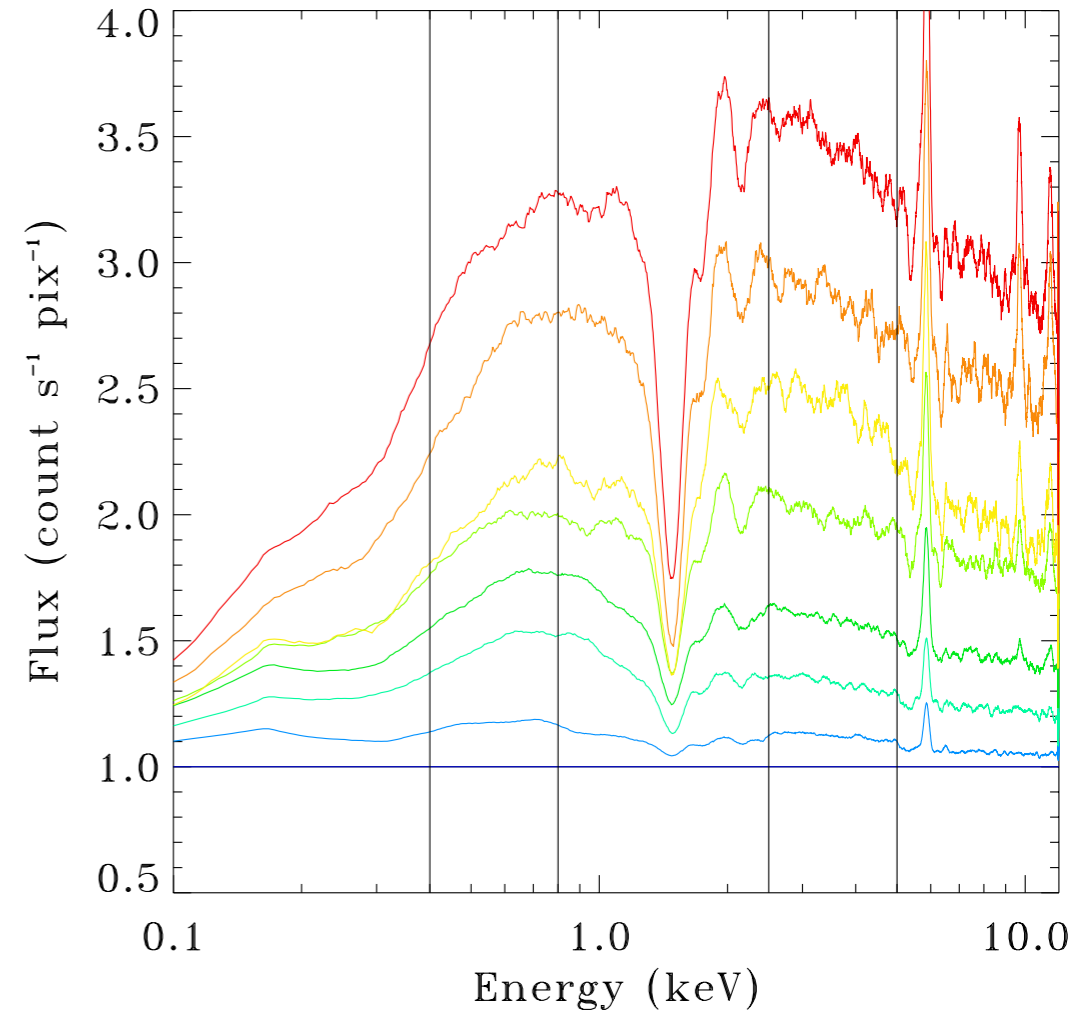

New Approach

Selecting spectra from regions DE&F and ΔR near the peak of the distribution and extracting spectra from obsids with different rates

- some variation below 0.6 keV

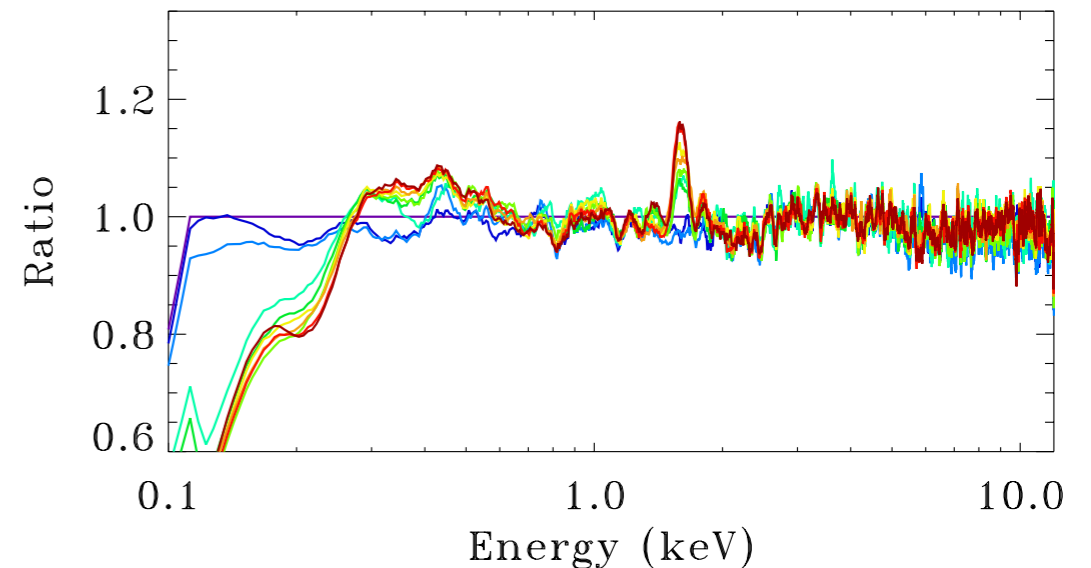
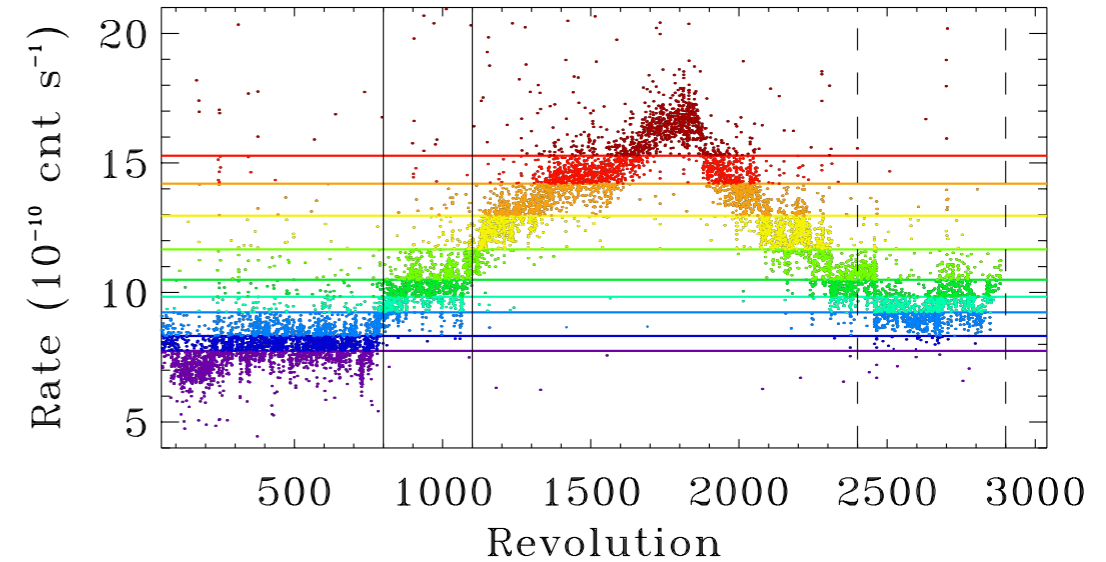

Selecting spectra from regions DE&F and ΔR near the peak of the distribution and a rate within certain limits and extracting spectra from obsids from different eras:

- some variation below 0.3 keV
- some variation around Al $K\alpha$
- long term gain variation?

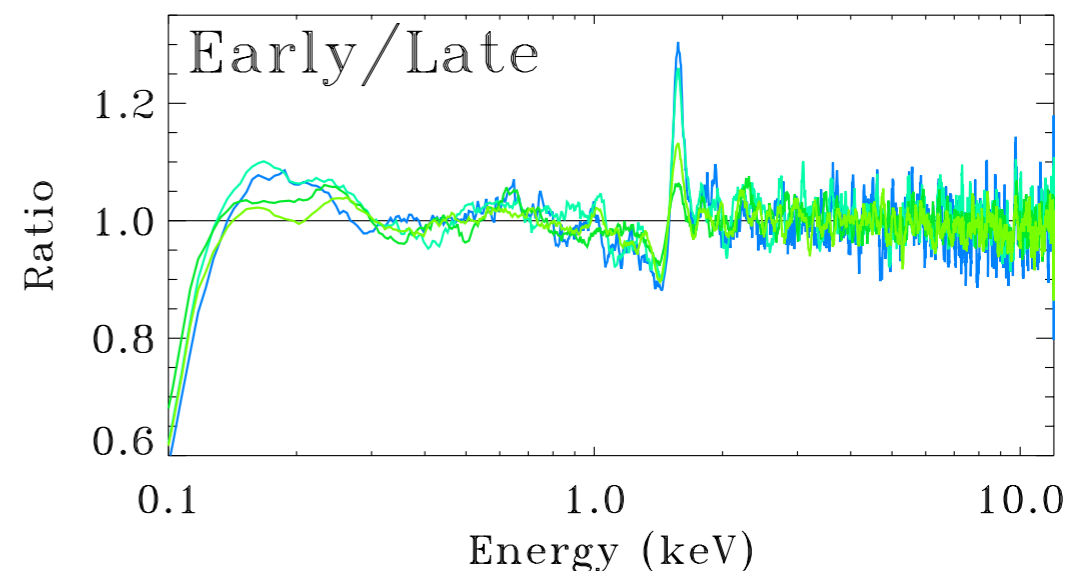

Does it Make a Difference?

We do not have enough data to explore the change in the spectrum shape over the complete three-dimensional phase space of R , ΔR , epoch.

Therefore, even if we wanted to create a background spectrum, ab initio from the R , distribution of ΔR over the observation, and epoch, we would have to make quite a few assumptions.

Furthermore, for observations taken within the last year, we do not yet have the corner data to determine $R(\text{rev})$ or measure ΔR . Therefore, some of this is rather otiose!

So how far wrong do we go if we choose a fiducial background spectrum?

Does it Make a Difference?

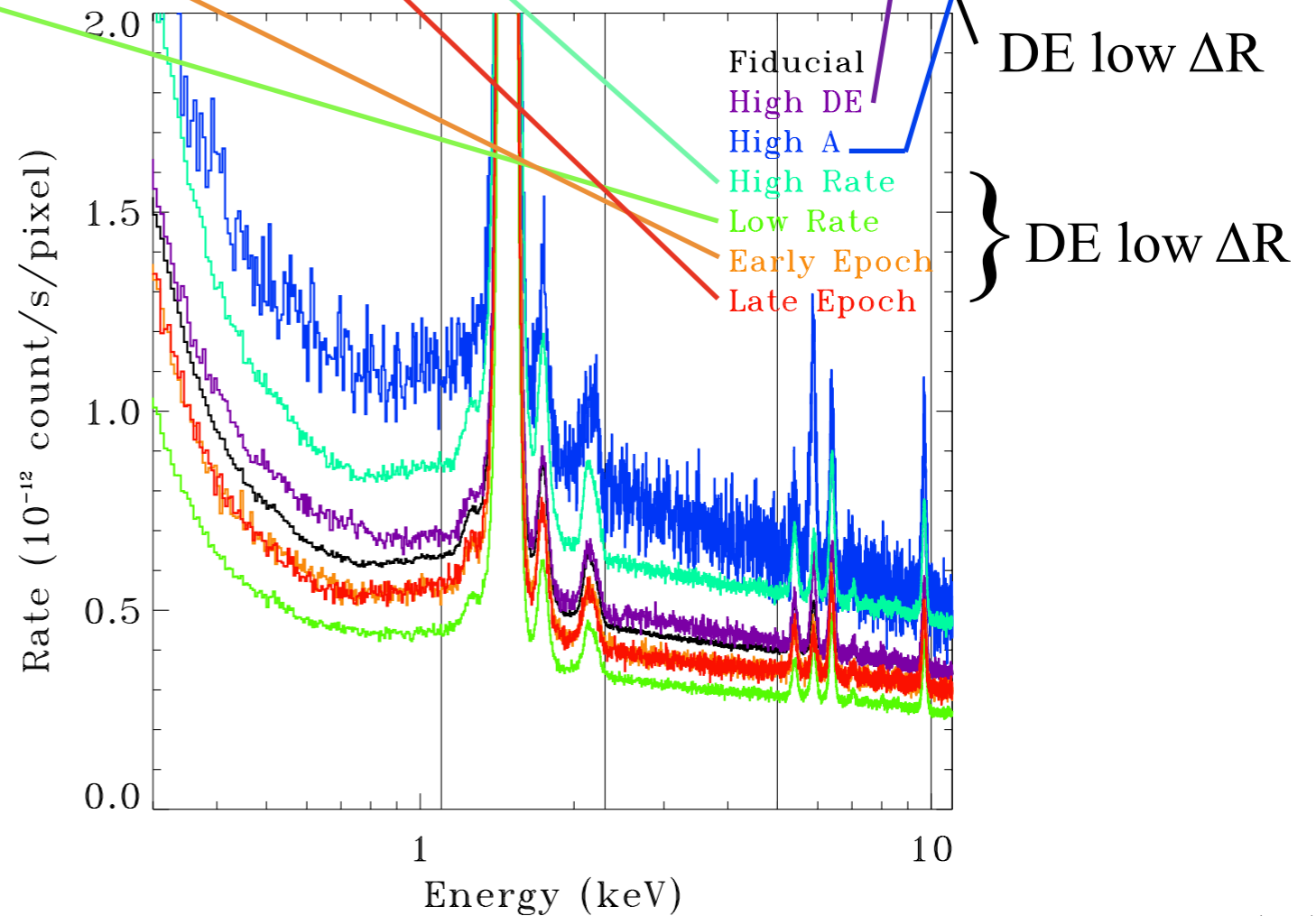
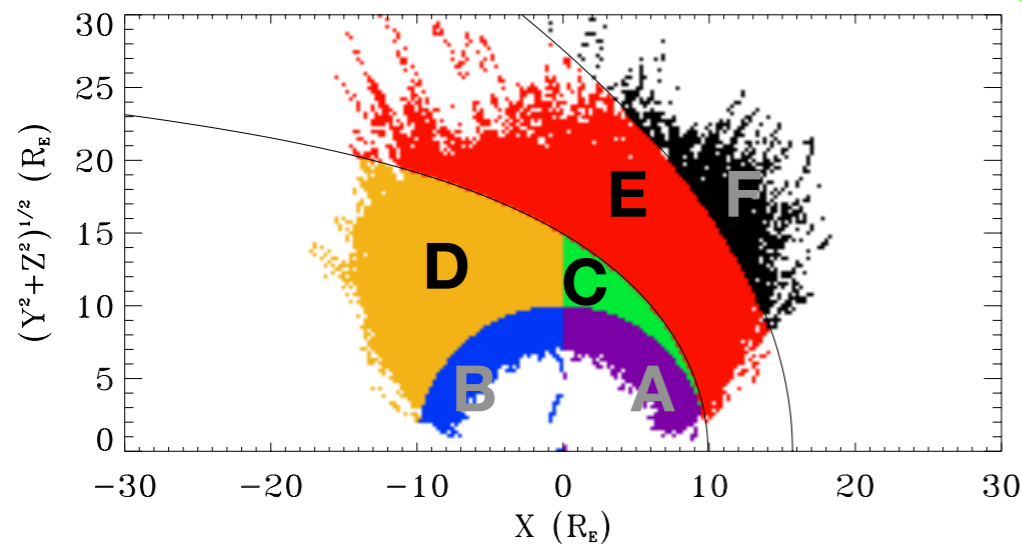
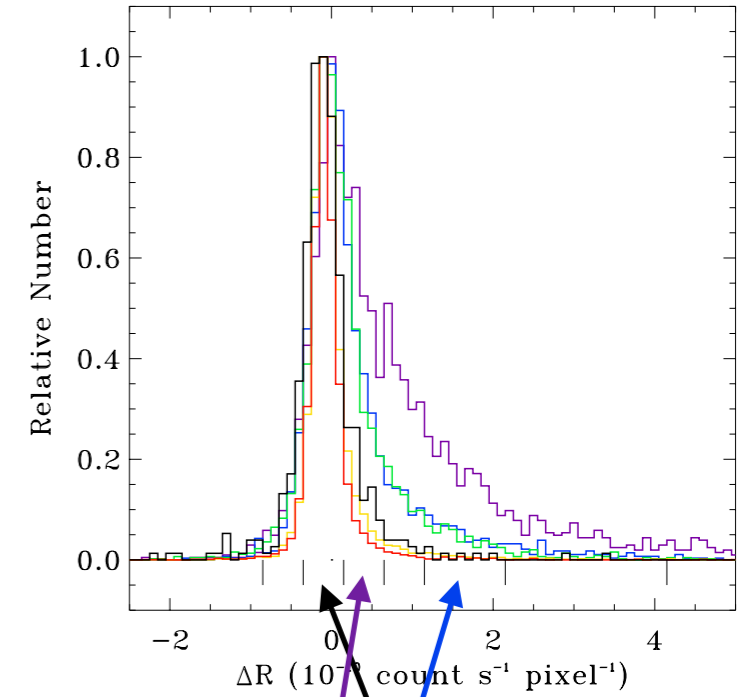
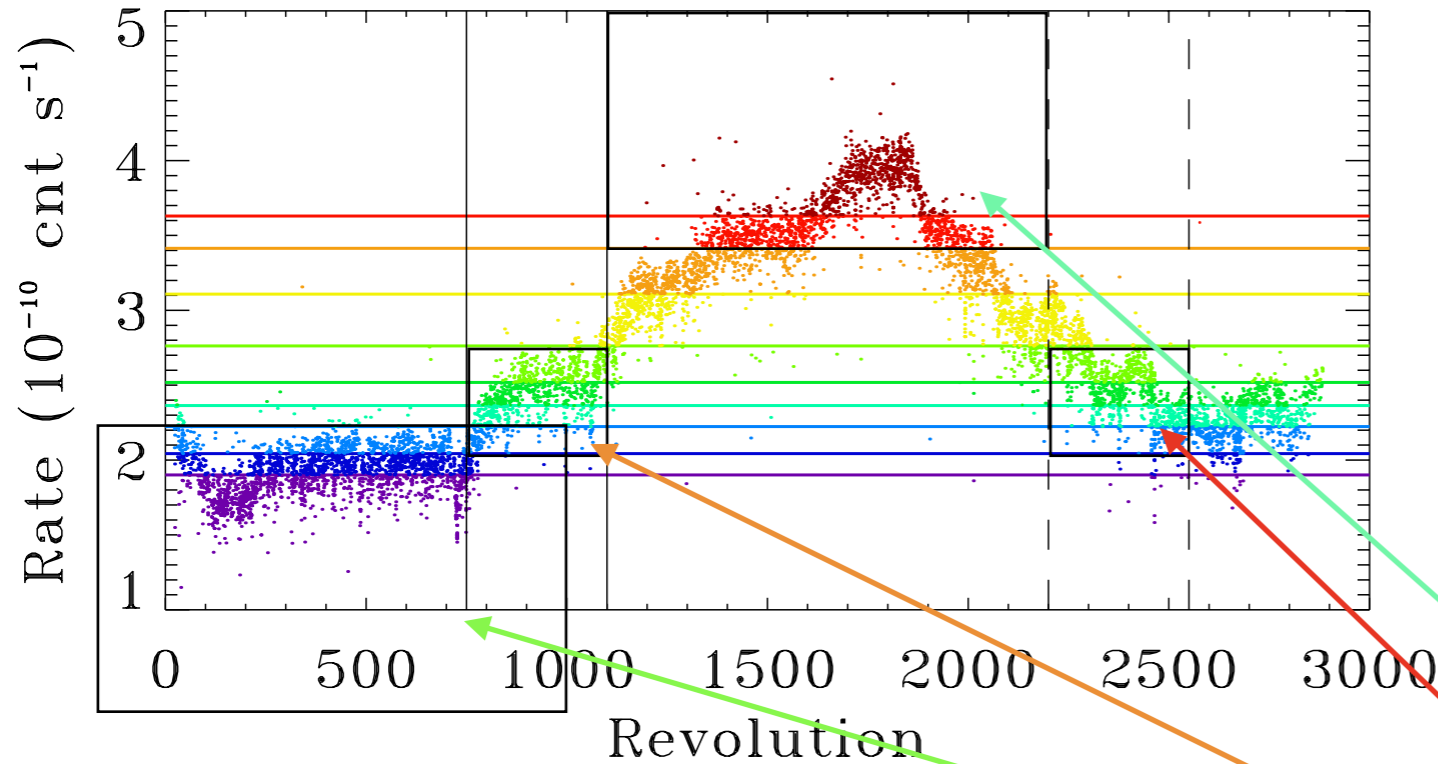

Step 1: Build fiducial spectrum and spectra representing various “extreme” cases.

Spectra ave'd over 4 chips.

Do it Make a Difference?

Step 2: For each spectrum, fit the continuum, typically $\chi^2_{\nu} \sim 1.05$

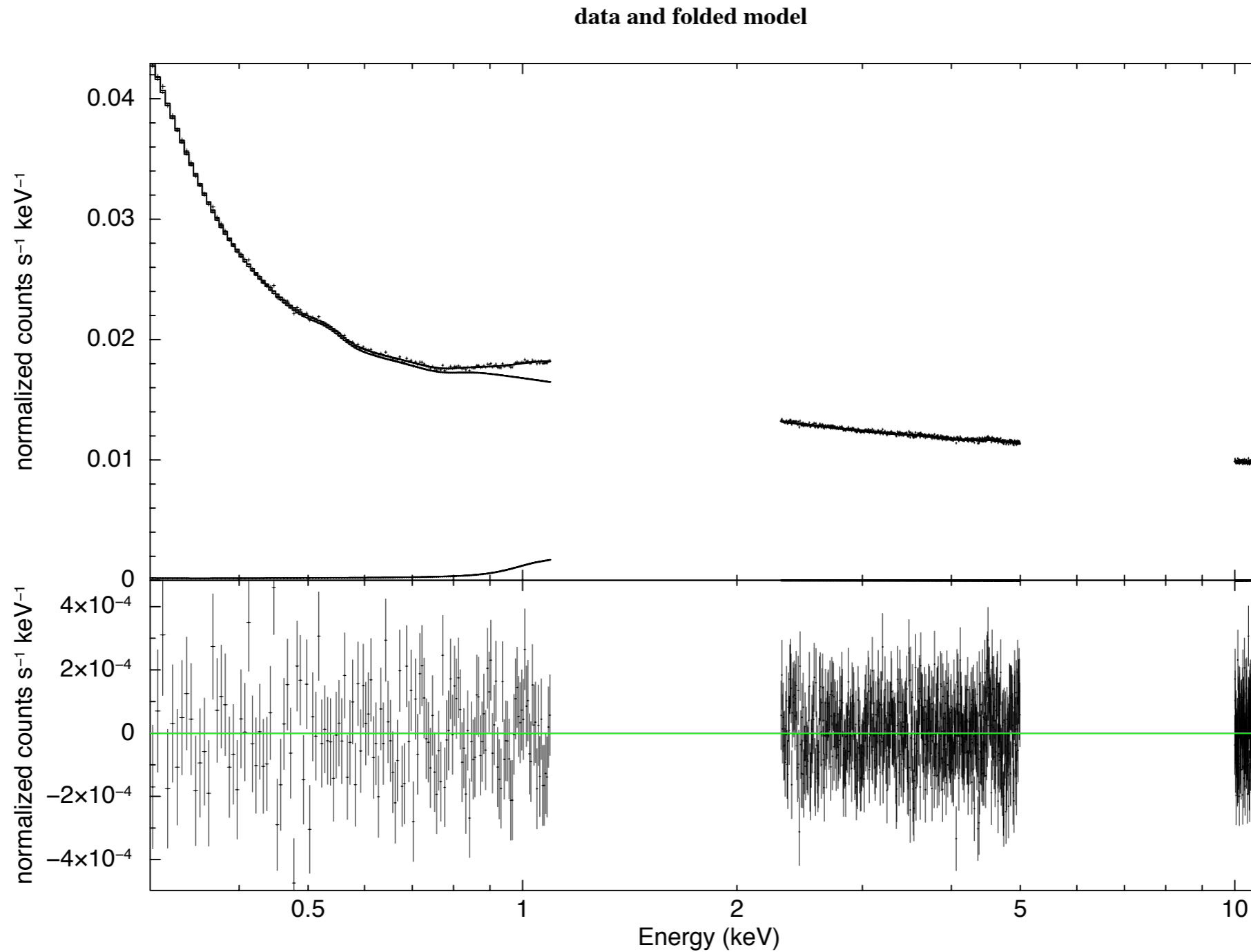

kuntz 28-Feb-2019 20:45

Do it Make a Difference?

Step 3: For each model create 1000 fake spectra with exposure time T

Fit each spectrum with fiducial model to get χ_v^2

Step 4: Repeat for exposures from 10 ks to 1 Ms

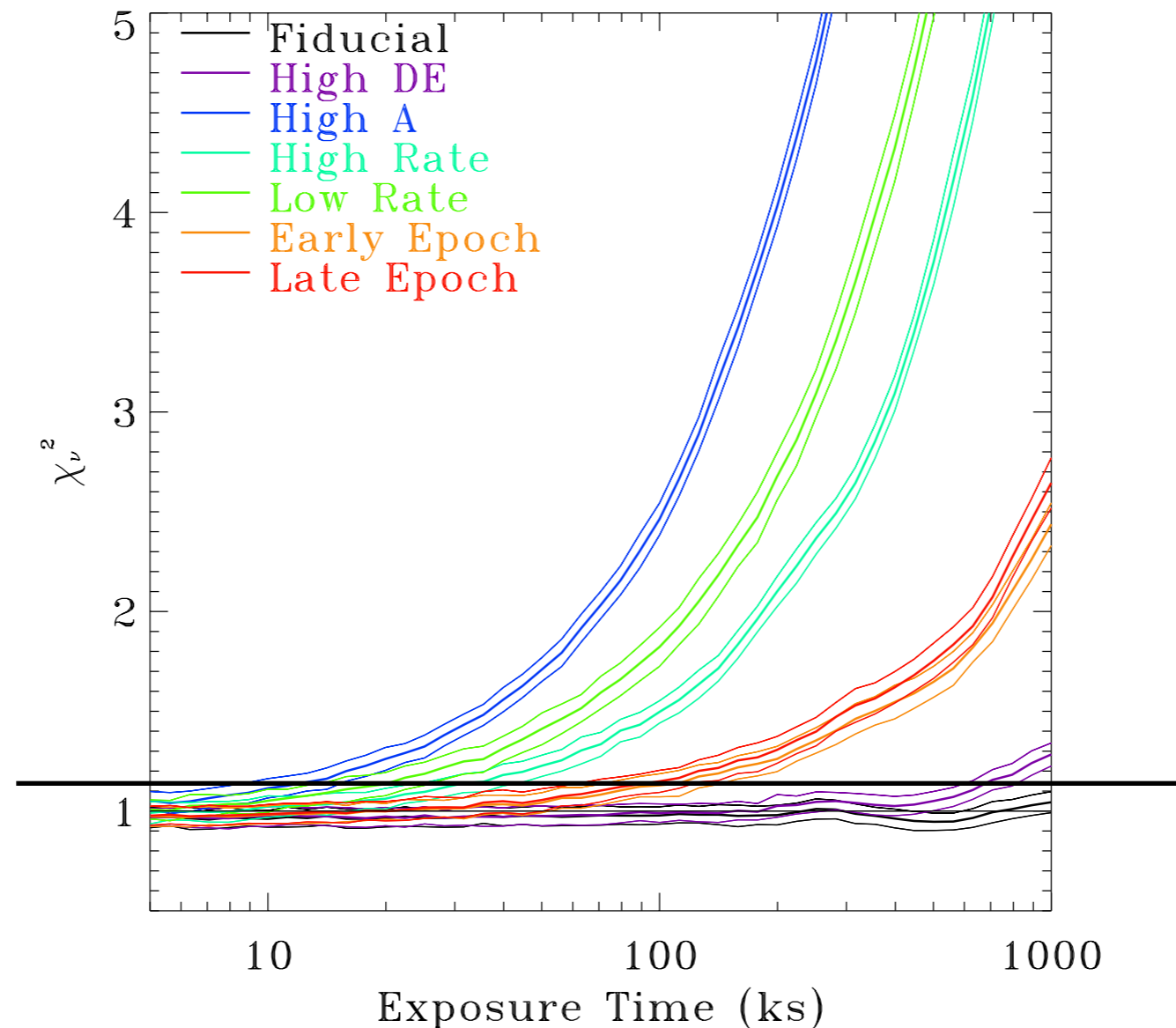

For 'extreme' epochs - would need ~ 100 ks exposure to see difference

For extreme rates - would need 20-40 ks exposures to see difference

For extreme ΔR - would need ~ 10 ks exposure to see the difference

Does it Make a Difference?

For variations in the epoch or the QDP rate the difference between the true background spectrum and the fiducial just becomes noticeable in the range of typical XMM exposure times.

Therefore, the fiducial is probably acceptable in these cases.

N.B. We are dealing with just the continuum here! Lines are Sui generis.

For variation in ΔR , the difference is noticeable in all but the shortest exposures. However, the high ΔR part of an observation may be short compared to the entire observation.

Therefore, the fiducial *may* be acceptable in these cases.

FWC Temporal Variation

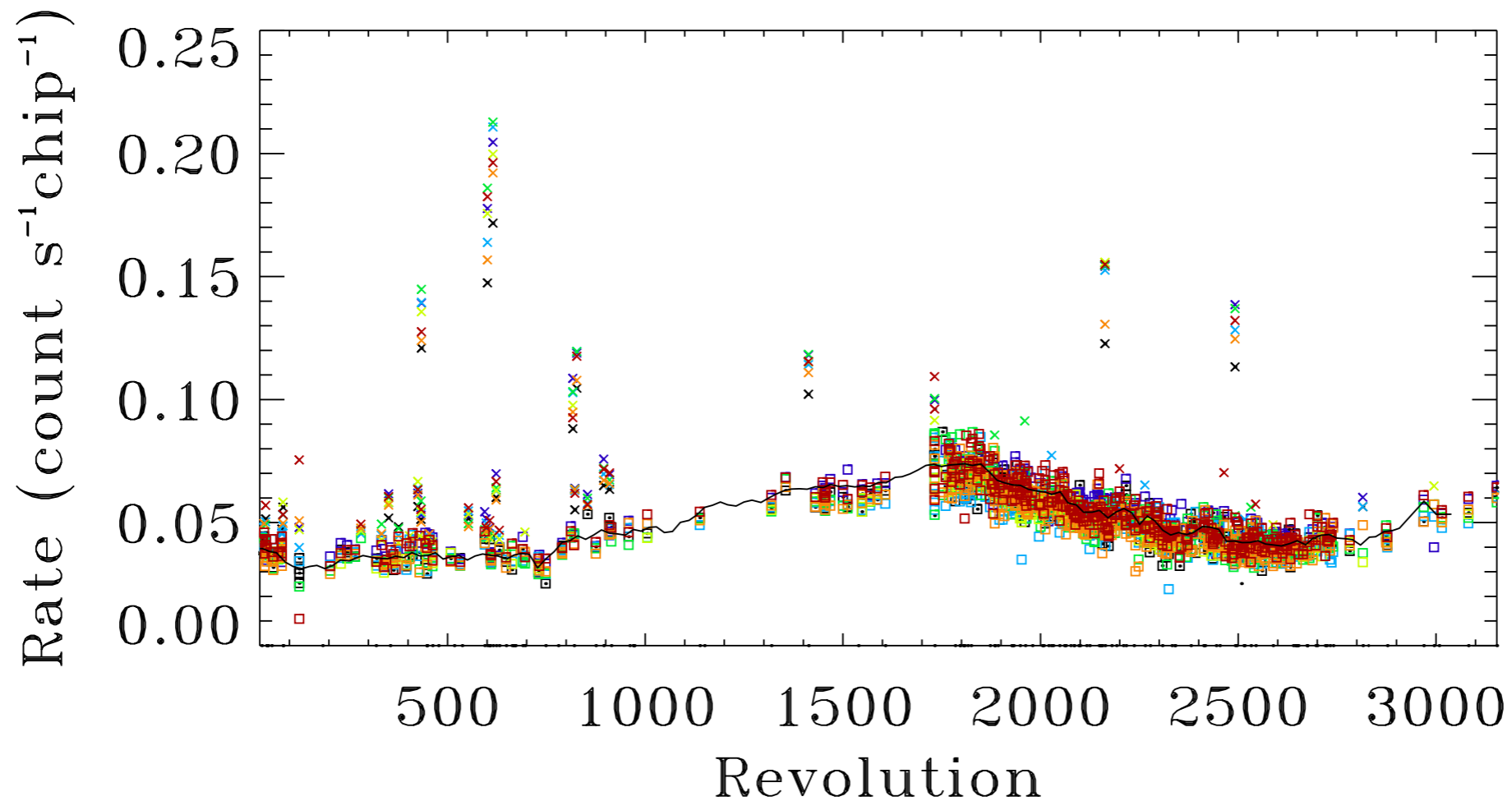

Most FWC data samples low ΔR times
- not enough high ΔR data to do any statistical analysis

FWC spatial variation

Current ESAS formulation:

Background = corner spectrum \times FWC spectrum / FWC corner spectrum

Problematic on a number of levels:

- 1.) It introduces noise since there isn't as much FWC data
- 2.) It modifies the underlying Poisson statistics
- 3.) It requires significant computation and lots of extraneous files

Do we really need to do this?

Is the FWC spectrum sufficiently uniform across each chip?

FWC Spatial Variation

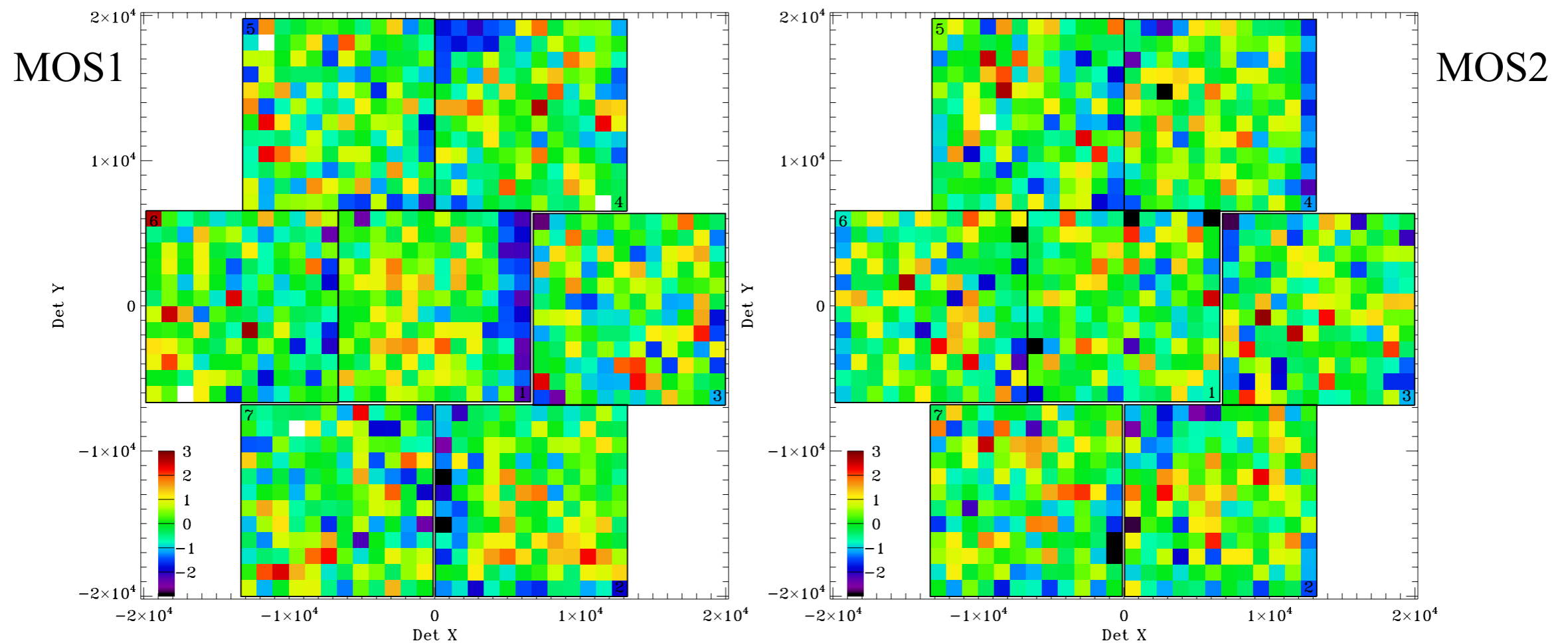

Maps of $HR (2.5-5.0)/(0.4-0.8)$ for the FWC data (non-anomalous data)

- each chip is relative smooth except
- MOS1-4 is a mess (but we already knew that)
- MOS1-1 has one edge that looks different
- MOS2-4 has one edge (removed by masking one row)

FWC Spatial Variation

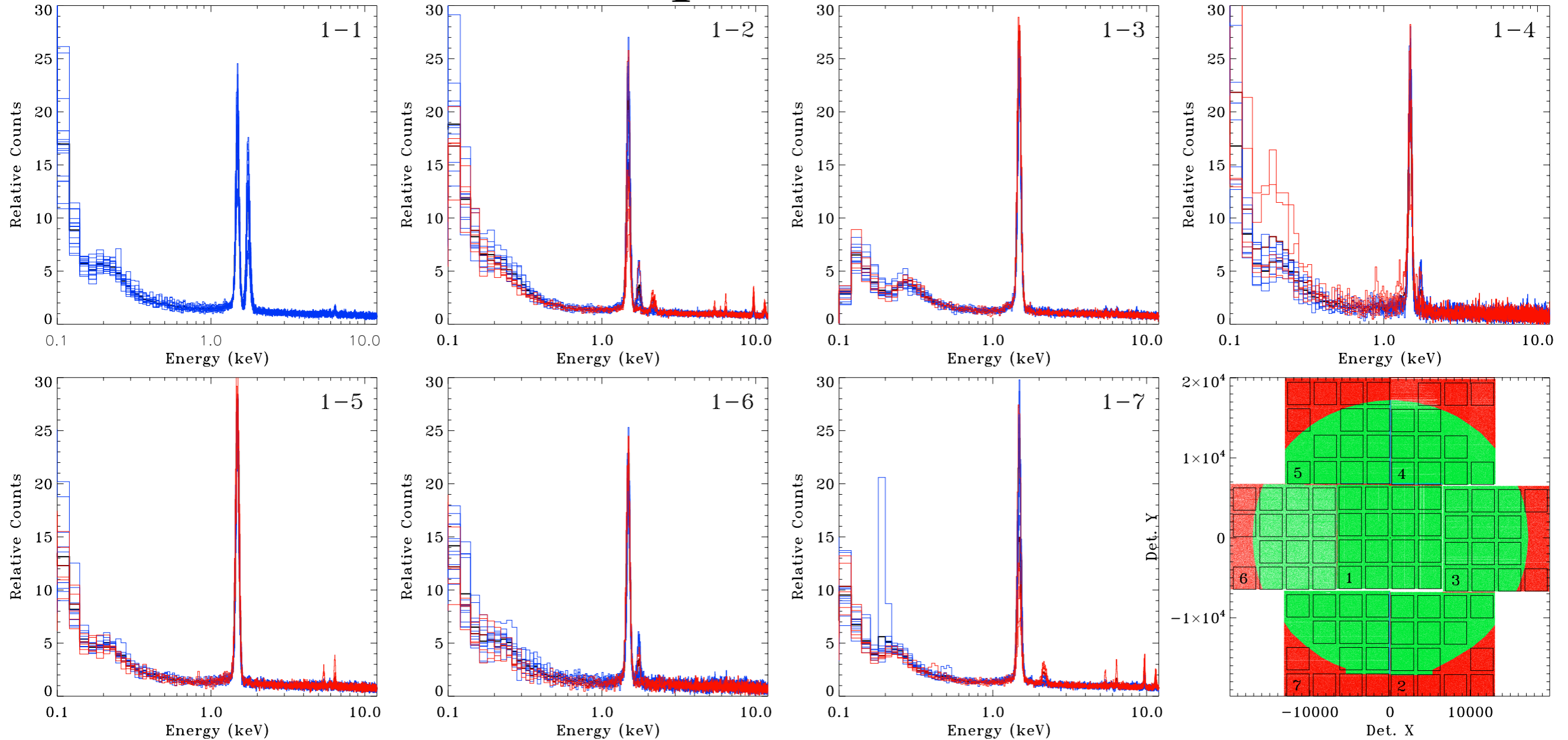

Red: FWC corner spectra. Blue: FWC FOV spectra

Black: (outer) 1σ for individual spectra, (inner) 1σ for mean FOV-mean corner

Crosses: mean FOV-mean corner

Strongly discrepant features usually due to “hot” regions for short periods

FWC Spatial Variation

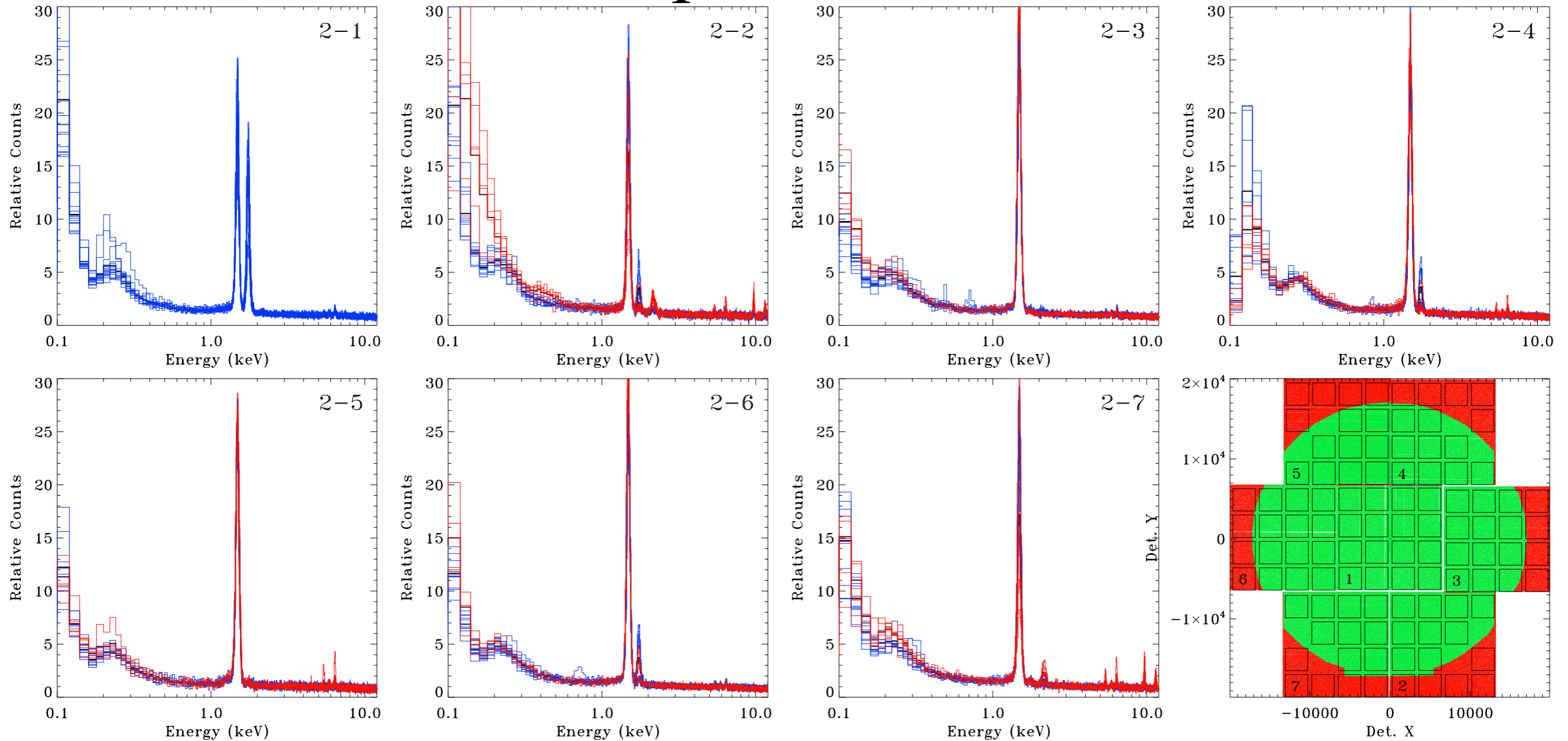

Red: FWC corner spectra. Blue: FWC FOV spectra

Black: (outer) 1σ for individual spectra, (inner) 1σ for mean FOV-mean corner

Crosses: mean FOV-mean corner

Strongly discrepant features usually due to “hot” regions for short periods

Note: bulk of discrepancies below 0.3 keV!

FWC Spatial Variation

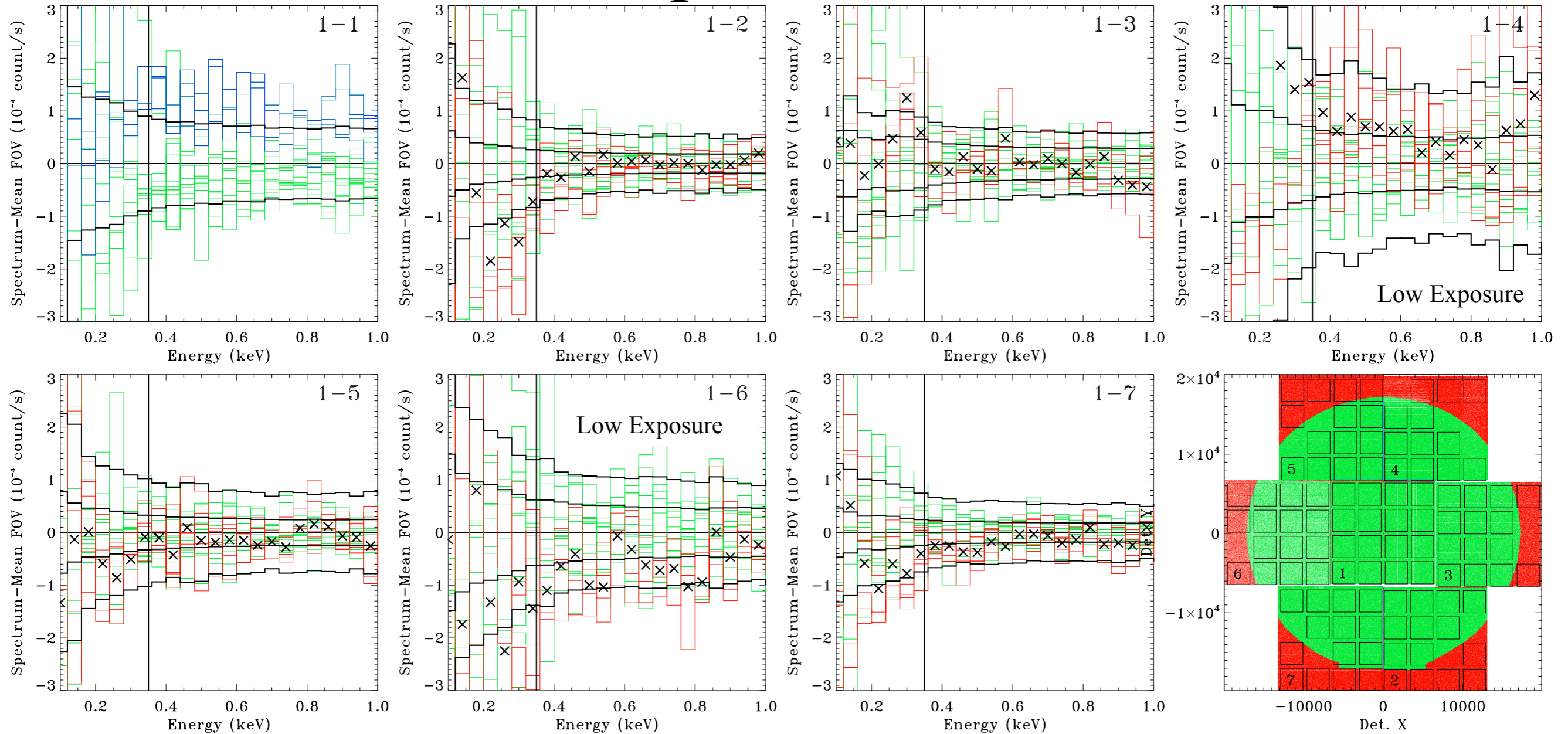

Red: FWC corner spectra. Green: FWC FOV spectra Blue: MOS1-1 edge
 Black: (outer) 1σ for individual spectra, (inner) 1σ for mean FOV-mean corner
 Crosses: mean FOV-mean corner

For most chips mean FOV-mean corner consistent with uncertainty for $E > 0.35$

FWC Spatial Variation

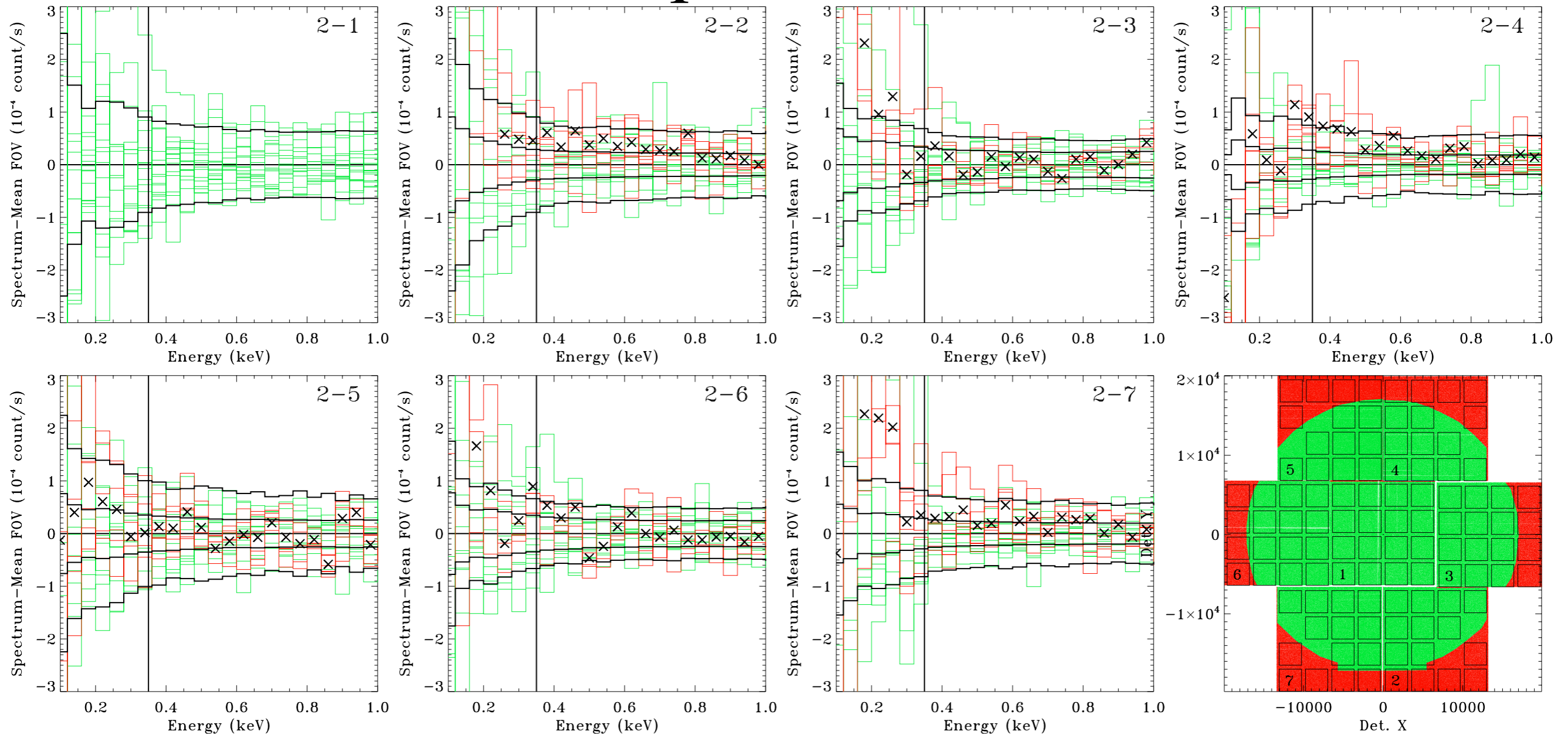

Red: FWC corner spectra. Green: FWC FOV spectra

Black: (outer) 1σ for individual spectra, (inner) 1σ for mean FOV-mean corner

Crosses: mean FOV-mean corner

For most chips mean FOV-mean corner consistent with uncertainty for $E > 0.35$

FWC Spatial Variation

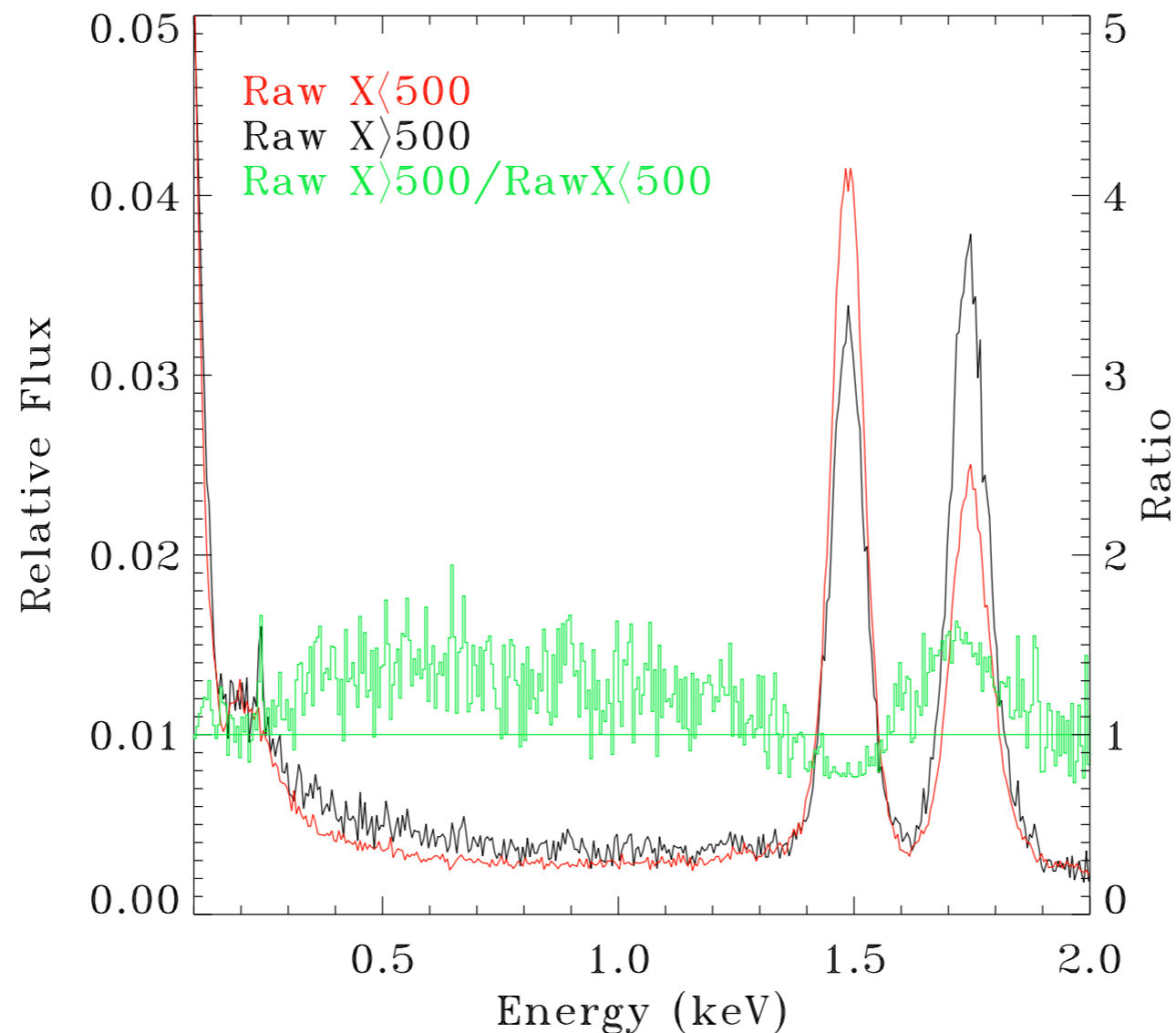

The primary non-uniformity is the edge on MOS1-1

- using the mean MOS1-1 background spectrum seriously wrong if source only in the 1/6th of the chip containing the edge.

- ESAS is intended for use over large fractions of the FOV so the effect is diluted

Is it diluted enough not to be distinguishable in 50-100 ks? **TBD**

Towards a New ESAS Implementation

For 1.) recent observations
2.) short observations
3.) casual use

We can provide fiducial corner spectra for most chips

It is not clear what to provide for MOS1-1 or MOS2-1 other than the much lower S/N FWC spectra after removing high ΔR periods (both measured and suspected).

We can provide tools to either calculate R, ΔR (for archival data) or estimate likelihood of high ΔR from orbit

For archival observations:

We can provide the current ESAS (not IACHEC approved) or

We can provide (?) spectrum based on region, ΔR based on those regions and maybe the overall QPB rate. MOS1-1 & MOS2-1 still a problem.

We *may* be able to provide a set of basis models with a description of how the parameters change with rate, ΔR , and epoch.

Towards a New ESAS Implementation

- Paracelsian/spagyric backgrounds?
- Work towards basis models for IACHEC
- Determine if MOS1-1 dilution makes edge problem ignorable
- Determine if combination of non-anomalous corners sufficient to describe the center chips.
- Build tool to guess ΔR from orbit and solar wind conditions
 - And maybe a tool to guess rate from sunspot number
- Current work done with (mostly) MOS2 - need to extract same data for MOS1 (requires a month or so of computation).
- **Settle on a strategy.**

Help?!?

Fig. 2-1 EPCH Design

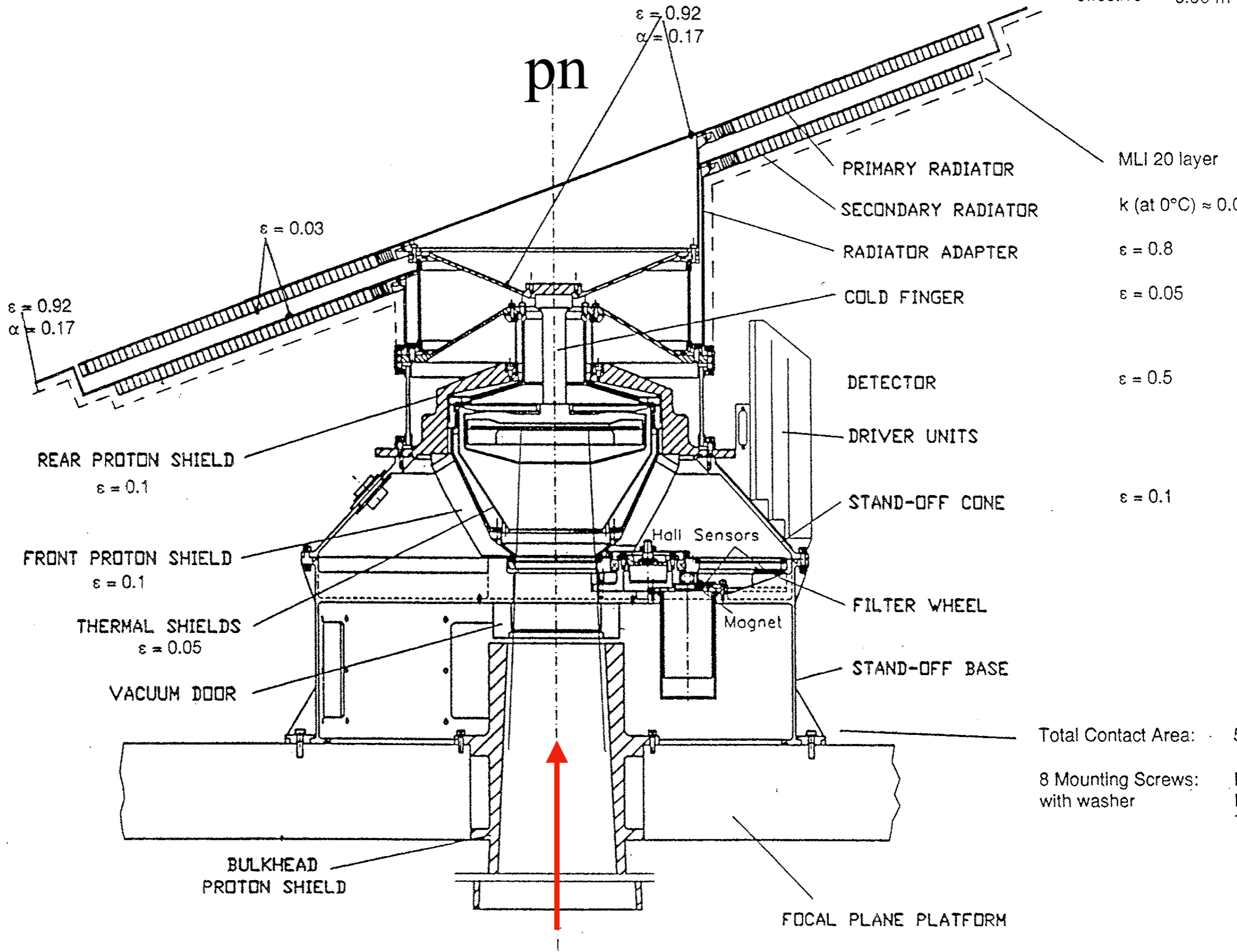

B.

MOS

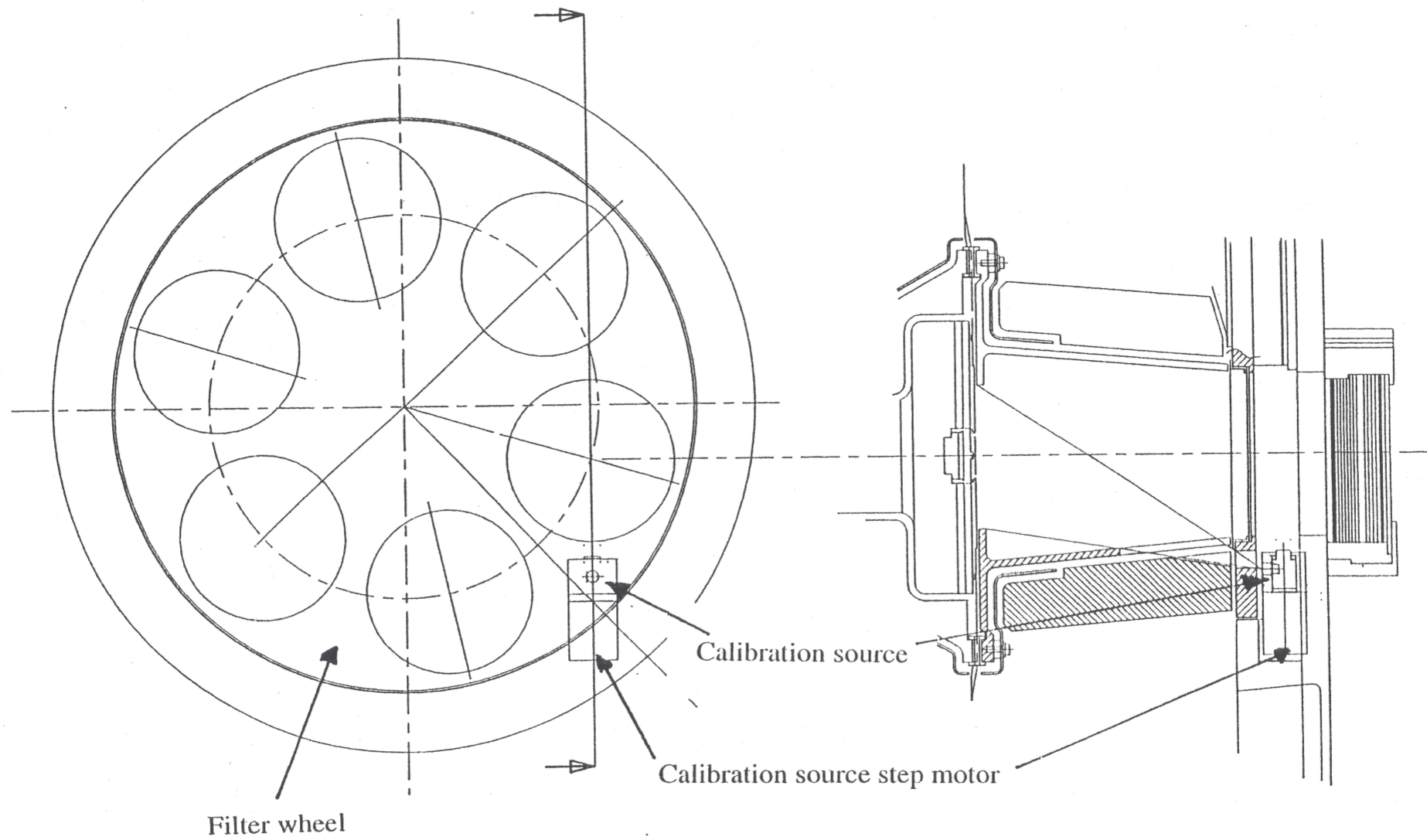

Calibration Source Mechanism

